

采用生态纸环保印刷 GOLDEN HORN

本产品手册资料由金角兽印制，仅用于说明本系列产品的相关信息。金角兽随时可能因技术升级或采用更新的生产工艺而改进本手册有关内容，或对本手册印刷错误及不准确的信息进行必要的改进和更改，恕不另行通知。商家订货时请随时联系本公司，以证实有关信息。

本画册采用生态纸印刷。珍惜资源，善待环境。

THIS ALBUM IS PRINTED ON ECOLOGICAL PAPER. CHERISH RESOURCES AND BE KIND TO THE ENVIRONMENT.

金属按钮系列



XB2施耐德型按钮系列



三色警灯系列



富士型AH164型开关

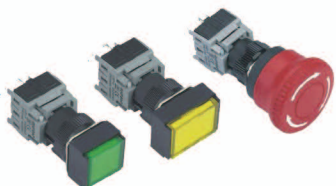

波纹管系列



气动元件

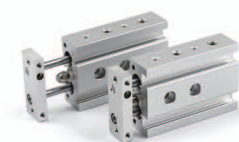

“金角兽”机械自动化设备控制系统产品提供商，更多产品详情介绍登入网站  
网址：[www.goldenhorn.cn](http://www.goldenhorn.cn)



☎ 4008-270-668

手机1: 134-1222-6797

手机2: 186-8005-2736

网址: [www.goldenhorn.cn](http://www.goldenhorn.cn)

地址: 广东省东莞市莞城区八达电子城 1 号



扫码进入商城



咨询客服1



咨询客服2



按钮开关     气动元件     波纹管     尼龙拖链

真实品质 · 创见未来

Machine Tool Accessories

CHAIN CABLE

机械自动化设备控制系统产品解决方案提供商

# Contents 目录

<b>T6/7/8 微型系列</b>	01	<b>H30 黄点加强型系列</b>	09	<b>拓展型系列</b>	16
<b>T10 微型系列</b>	02	<b>H35 黄点加强型系列</b>	10	<b>底座造型及尺寸图</b>	18
<b>T15 小型系列</b>	03	<b>H40 黄点加强型系列</b>	11	<b>TP系列新款一层三色LED警示灯</b>	19
<b>T18 小型系列</b>	04	<b>H45 黄点加强型系列</b>	12	<b>TW系列白色多层式LED警示灯</b>	20
<b>T25 黑体经济型系列</b>	05	<b>H55 黄点加强型系列</b>	13	<b>T8系列黑色多层式LED警示灯</b>	21
<b>S25 静音系列</b>	06	<b>H60 黄点加强型系列</b>	14	<b>D-2071系列小型内屏LED警示灯</b>	22
<b>H20 黄点加强型系列</b>	07	<b>H65 黄点加强型系列</b>	15	<b>D-1081系列电子旋转LED警示灯</b>	23
<b>H25 黄点加强型系列</b>	08	<b>HS 黄点加强型系列</b>	16	<b>D-1101系列电子旋转LED警示灯</b>	24
<b>波纹管</b>	30	<b>配电柜配电箱</b>	35		

## 订货型号表示方法

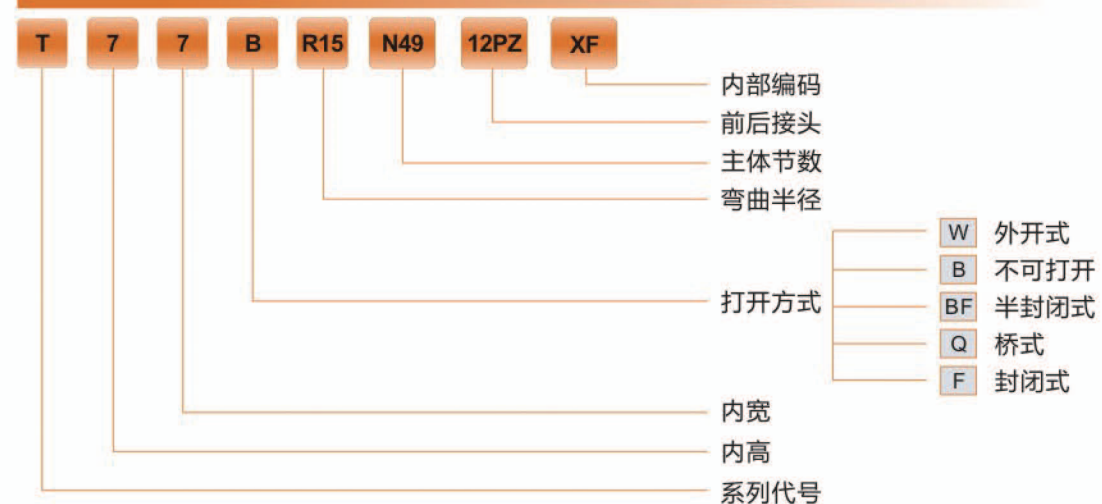

例如：

T7.7.B.R15.N49.12PZ-XF表示型号为：微型系列7×7不可打开，角度R15，49节，带前后接头。

H25.25.Q.R55.N25.12PZ-XF表示型号为：加强型系列25×25桥式，角度为R55，25节，带前后接头。

## T6/7/8 微型系列



接头安装尺寸图

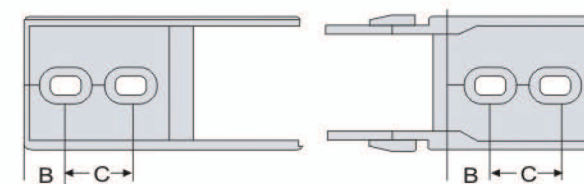
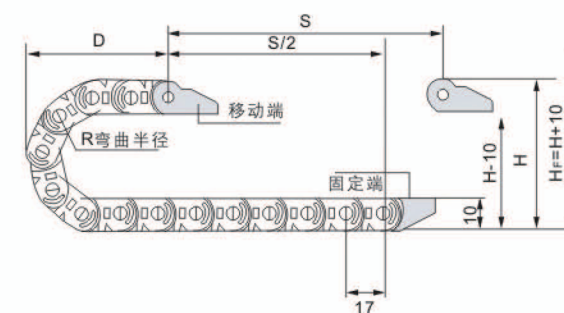

主要技术参数

6系列  
节距=13mm，不含接头每米节数=77，链长=S/2+K，S=行程距离，K=π·R+“安全量”

7系列  
节距=17mm，不含接头每米节数=59，链长=S/2+K，S=行程距离，K=π·R+“安全量”

6系列		7系列		8系列		
R	15	R	15	28	R	18
H	39	H	40	66	H	47
D	33	D	37	50	D	41
K	75	K	80	121	K	91

8系列  
节距=16mm，不含接头每米节数=69，链长=S/2+K，S=行程距离，K=π·R+“安全量”

技术参数表

系列号	内高	内宽	外高	外宽	弯曲半径(R)	打开方式	孔径	对应接头孔距(mm)	接头订购型号
T6微型系列	6	10	9	15	15	桥式外开	3.2×4.7	B=5 C=8	6.10.W.12PZ
T7微型系列	7	7	10	14	15, 28	桥式不可打开	3×4.5	B=5 C=8	7.7.B.12PZ
T8微型系列	8	8	11	15	18	桥式不可打开	3.5×5	B=5 C=9	8.8.B.12PZ

# T10 微型系列



接头安装尺寸图

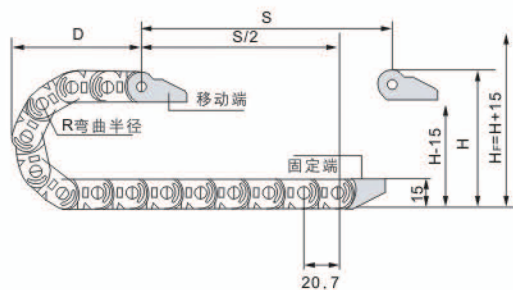

主要技术参数

节距=20.7mm, 不含接头每米节数=49, 链长= $S/2+K$ , S=行程距离,  $K=\pi \cdot R$ +“安全量”

R	18	28	38
H	51	71	91
D	47	57	67
K	101	133	164

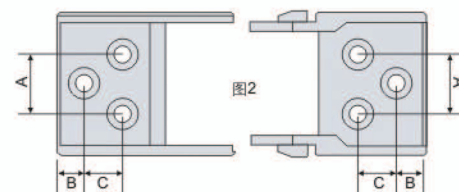
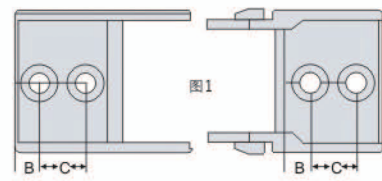
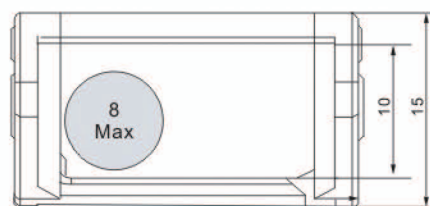

技术参数表

系列号	内高	内宽	外高	外宽	弯曲半径(R)	打开方式	孔径(mm)	对应接头孔距(mm)	接头订购型号
T10微型系列	10	10	15	18	18, 28, 38	桥式不可打开	4 × 7L	B=8 C=9	10.10.B.12PZ(图1)
	10	15	15	23				B=8 C=9	10.15.B.12PZ(图1)
	10	20	15	28				A=12 B=8 C=9	10.20.B.12PZ(图2)
	10	30	15	38				A=12 B=8 C=9	10.30.B.12PZ(图2)

# T15 小型系列



接头安装尺寸图

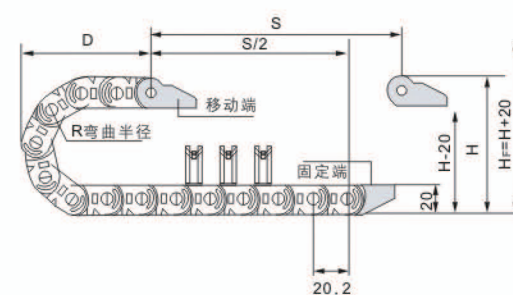

主要技术参数

节距=20.2mm, 不含接头每米节数=50, 链长= $S/2+K$ , S=行程距离,  $K=\pi \cdot R$ +“安全量”

R	28	38	48
H	76	96	116
D	59	69	79
K	140	171	203

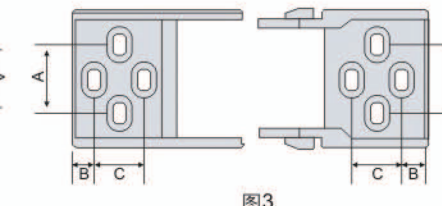
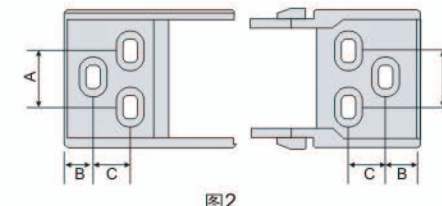
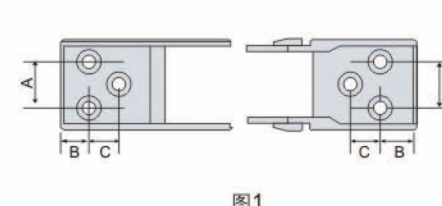

技术参数表

系列号	内高	内宽	外高	外宽	弯曲半径(R)	打开方式	孔径(mm)	对应接头孔距(mm)	接头订购型号
T15小型系列 半封闭	15	15	20	25	28, 38, 48	半封闭内开	4 × 7L	A=9.5 B=9.5 C=6.5	15.15.BF.12PZ(图1)
	15	20	20	30				A=10 B=4 C=6.5	15.20.BF.12PZ(图2)
	15	30	20	40				A=20 B=3.5 C=12	15.30.BF.12PZ(图3)
	15	40	20	50				A=28 B=4.5 C=14	15.40.BF.12PZ(图3)
	15	50	20	60				A=40 B=4 C=12	15.50.BF.12PZ(图3)

# T18小型系列



## 接头安装尺寸图

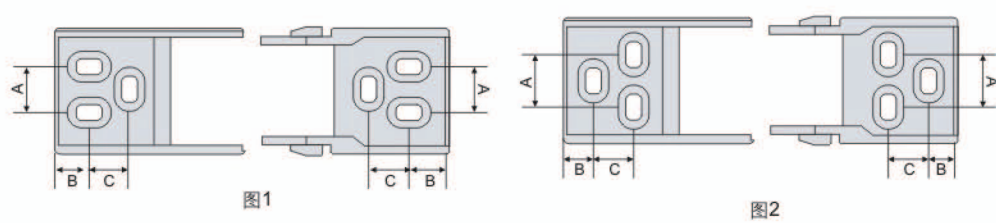
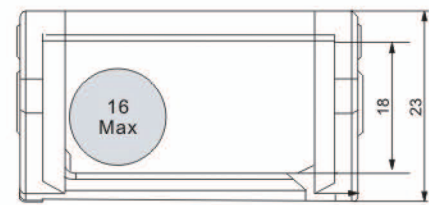
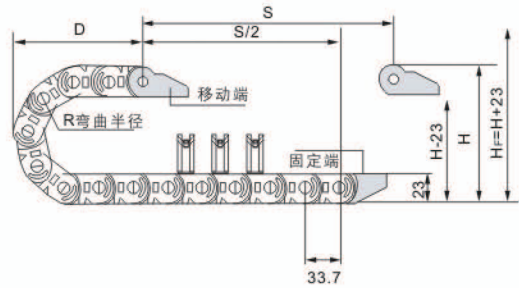

## 主要技术参数

节距=33.7mm, 不含接头每米节数=30, 链长=S/2+K, S=行程距离, K=π·R+“安全量”

R	28	38	48	55	60	75	100
H	79	99	119	133	143	173	223
D	74	84	94	101	106	121	146
K	158	190	221	243	259	306	384

## 技术参数表

系列号	内高	内宽	外高	外宽	弯曲半径(R)	打开方式	孔径(mm)	对应接头孔距(mm)	接头订购型号
T18小型系列 半封闭	18	18	23	29	28, 38, 48 55, 60, 75 100	半封闭内开	5×7L	A=8 B=11.5 C=9	18.18.BF.12PZ(图1)
	18	25	23	36			5×8.5L	A=12 B=7.5 C=11	18.25.BF.12PZ(图2)
	18	37	23	47			5×9L	A=24.5 B=7.5 C=7.5	18.37.BF.12PZ(图2)
	18	50	23	60			5×9L	A=37.5 B=8 C=7	18.50.BF.12PZ(图2)
T18小型系列桥式	18	18	23	24	38, 48, 60	桥式内开	5×7L	A=8 B=11.5 C=9	18.18.Q.12PZ(图1)
	18	25	23	36			5×8.5L	A=12 B=7.5 C=11	18.25.Q.12PZ(图2)
	18	37	23	47			5×9L	A=24.5 B=7.5 C=7.5	18.37.Q.12PZ(图2)
	18	50	23	60			5×9L	A=37.5 B=8 C=7	18.50.Q.12PZ(图2)

# T25黑体经济型系列



## 接头安装尺寸图

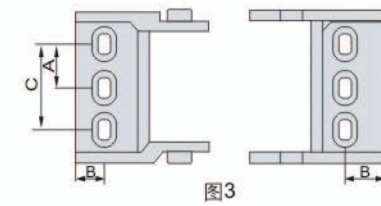
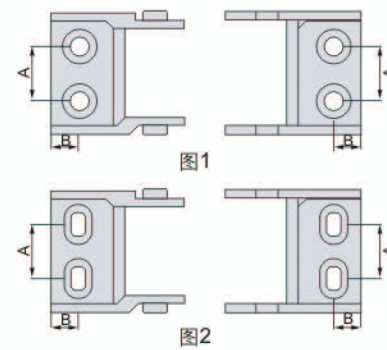
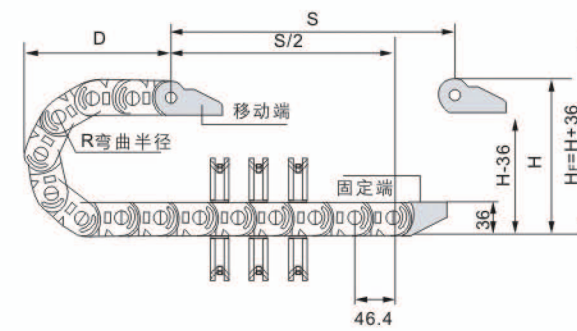

## 主要技术参数

节距=46.4mm, 不含接头每米节数=22, 链长=S/2+K, S=行程距离, K=π·R+“安全量”

R	40	55	75	100	125	150	175
H	116	146	186	236	286	336	386
D	105	120	140	165	190	215	240
K	229	276	339	417	496	574	653

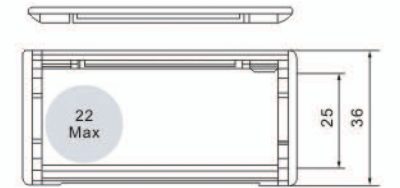

## 技术参数表

系列号	内高	内宽	外高	外宽	弯曲半径(R)	打开方式	孔径(φ)	对应接头孔距(mm)	接头订购型号
T25系列	25	25	36	40	40, 55, 75, 100 125, 150, 175	桥式	6.3	A=14 B=11.5	25.25.Q.12PZ(图1)
	25	38	36	53		桥式/封闭		A=22 B=11.5	25.38.Q(F).12PZ(图2)
	25	50	36	65		桥式/封闭		A=29 B=11.5	25.50.Q(F).12PZ(图2)
	25	57	36	72		桥式/封闭		A=36 B=11.5	25.57.Q(F).12PZ(图2)
	25	60	36	75		桥式/封闭		A=36 B=11.5	25.60.Q(F).12PZ(图2)
	25	77	36	92		桥式/封闭		A=28 B=11.5 C=56	25.77.Q(F).12PZ(图3)
	25	103	36	118		桥式		A=27.5 B=11.5 C=82.5	25.103.Q.12PZ(图4)

# S25 静音系列



接头安装尺寸图

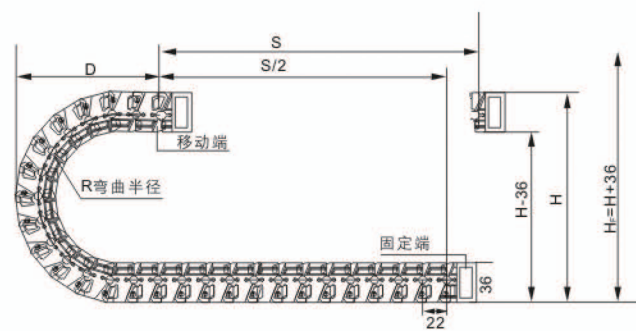

主要技术参数

节距=22mm, 不含接头每米节数=46, 链长=S/2+K, S=行程距离, K= $\pi \cdot R$ +“安全量”

R	55	75	100	125
H	146	186	236	286
D	95	115	140	165
K	252	315	393	472

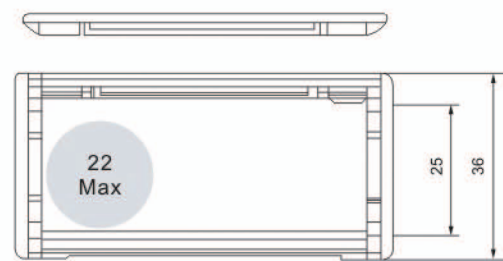
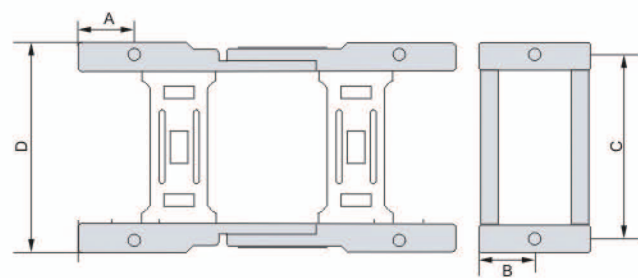

技术参数表

系列号	内高	内宽	外高	外宽	弯曲半径(R)	打开方式	对应接头孔距(mm)	孔径(φ)
S25 静音系列	25	25	36	43	55, 75, 100, 125	桥式	A=9 B=18 C=35 D=45	6
	25	38	36	56		桥式	A=9 B=18 C=48 D=58	
	25	50	36	68		桥式	A=9 B=18 C=60 D=70	
	25	57	36	75		桥式	A=9 B=18 C=67 D=77	
	25	77	36	95		桥式	A=9 B=18 C=87 D=97	

# H20 黄点加强型系列



可根据客户要求  
进行配色生产

接头安装尺寸图

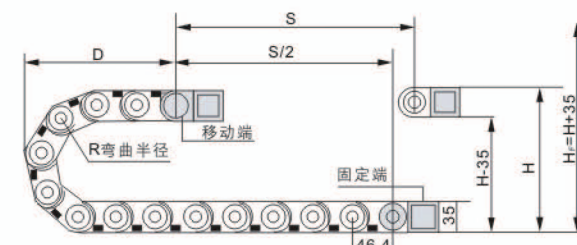

主要技术参数

节距=46.4mm, 不含接头每米节数=22, 链长=S/2+K, S=行程距离, K= $\pi \cdot R$ +“安全量”

R	55	75	100	125	150	175
H	145	185	235	285	335	385
D	119	139	164	189	214	239
K	275	337	416	494	573	651

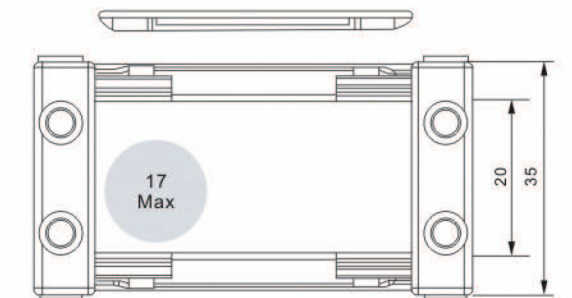
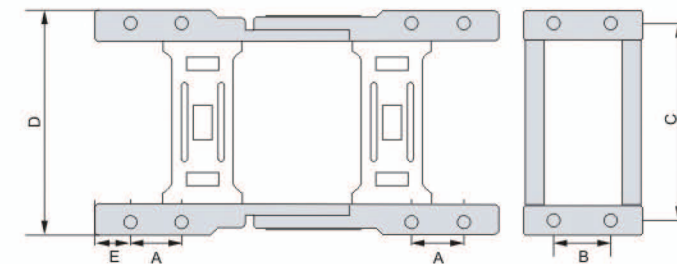

技术参数表

系列号	内高	内宽	外高	外宽	弯曲半径(R)	打开方式	节距	A	B	C	D	E	孔径(φ)		
H20系列	20	25	35	43	55, 75, 100, 125, 150, 175	桥式	46	16	16	38	46	9.5	6		
	20	38	35	56		桥式/封闭								51	59
	20	50	35	68		桥式/封闭								63	71
	20	57	35	75		桥式/封闭								70	78
	20	60	35	78		桥式/封闭								73	81
	20	77	35	95		桥式/封闭								90	98
	20	103	35	121		桥式								116	124

## H25 黄点加强型系列



接头安装尺寸图

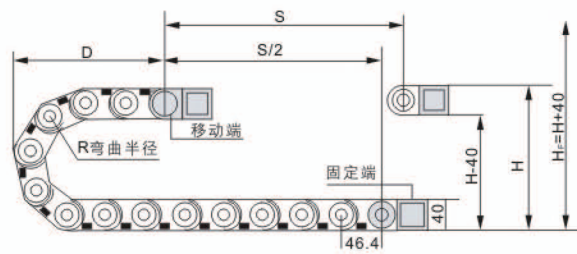

主要技术参数

节距=46.4mm, 不含接头每米节数=22, 链长=S/2+K, S=行程距离, K=π·R+“安全量”

R	55	75	100	125	150	175
H	150	190	240	290	340	390
D	122	142	167	192	217	242
K	282	345	424	502	581	659

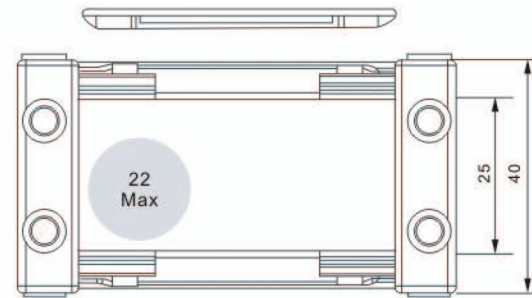
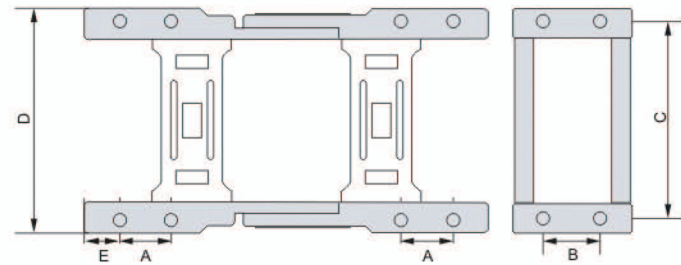

技术参数表

系列号	内高	内宽	外高	外宽	弯曲半径(R)	打开方式	节距	A	B	C	D	E	孔径
H25系列	25	25	40	43	55, 75, 100, 125, 150, 175	桥式	46	16	16	38	46	9.5	6
	25	38	40	56		桥式/封闭				51	59		
	25	50	40	68		桥式/封闭				63	71		
	25	57	40	75		桥式/封闭				70	78		
	25	60	40	78		桥式/封闭				73	81		
	25	77	40	95		桥式/封闭				90	98		
	25	103	40	121		桥式				116	124		

## H30 黄点加强型系列

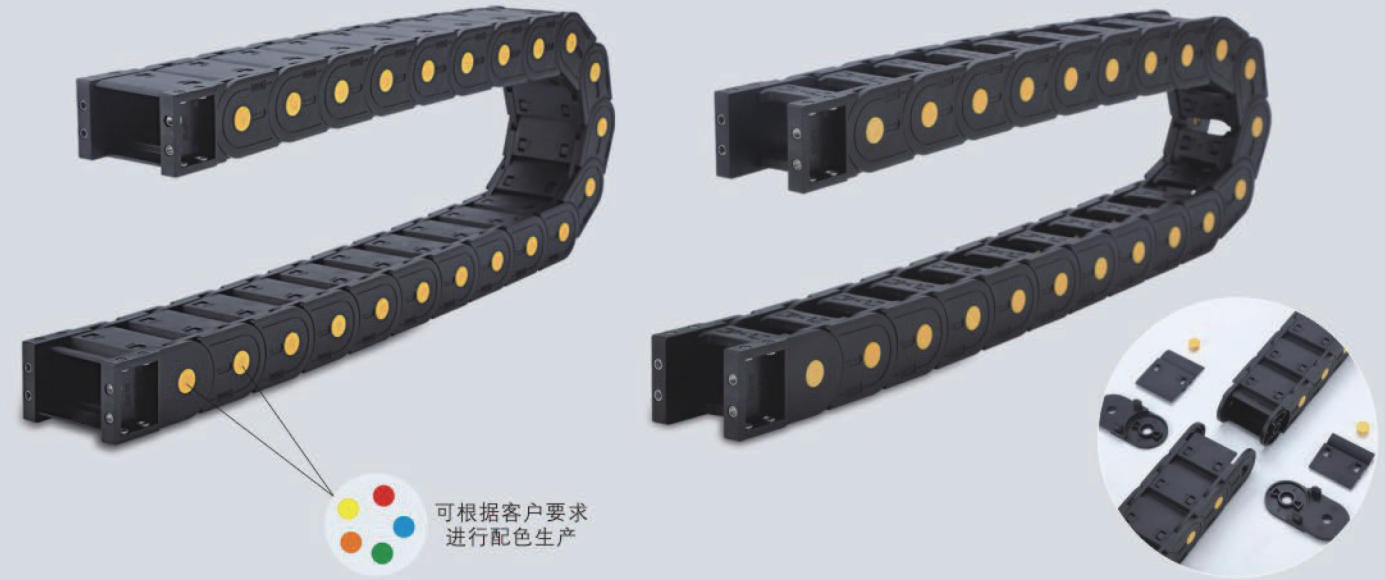

接头安装尺寸图

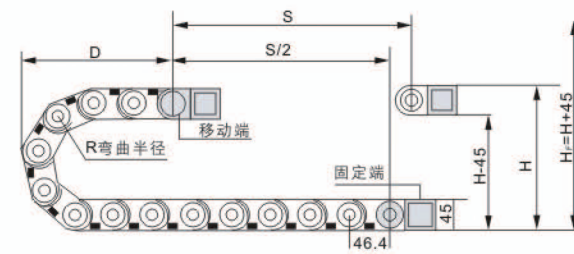

主要技术参数

节距=46.4mm, 不含接头每米节数=22, 链长=S/2+K, S=行程距离, K=π·R+“安全量”

R	55	75	100	125	150	175
H	155	195	245	295	345	395
D	124	144	169	194	219	244
K	290	353	432	510	589	667

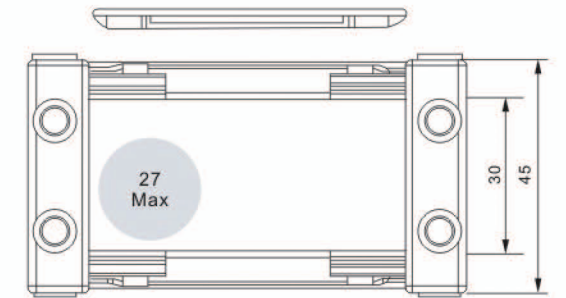
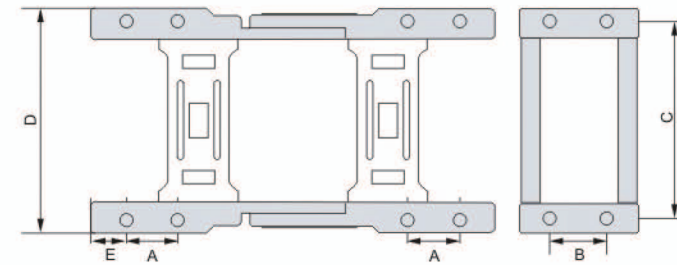

技术参数表

系列号	内高	内宽	外高	外宽	弯曲半径(R)	打开方式	节距	A	B	C	D	E	孔径
H30系列	30	25	45	43	55, 75, 100, 125, 150, 175	桥式	46	16	16	38	46	9.5	6
	30	38	45	56		桥式/封闭				51	59		
	30	50	45	68		桥式/封闭				63	71		
	30	57	45	75		桥式/封闭				70	78		
	30	60	45	78		桥式/封闭				73	81		
	30	77	45	95		桥式/封闭				90	98		
	30	103	45	121		桥式				116	124		

## H35 黄点加强型系列



可根据客户要求  
进行配色生产

接头安装尺寸图

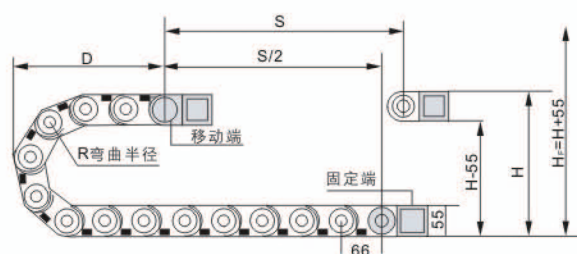

主要技术参数

节距=66mm, 不含接头每米节数=15, 链长=S/2+K, S=行程距离, K=π·R+“安全量”

R	75	100	125	150	200	250
H	205	255	305	355	455	555
D	169	194	219	244	294	344
K	388	467	545	624	781	938

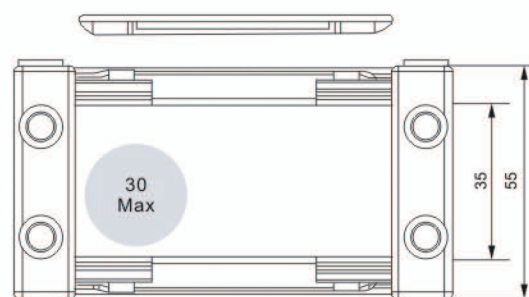
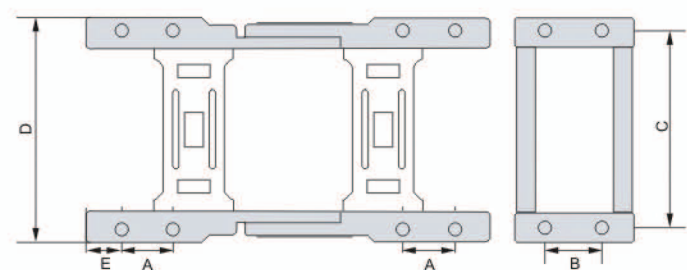

技术参数表

系列号	内高	内宽	外高	外宽	弯曲半径(R)	打开方式	节距	A	B	C	D	E	孔径
H35系列	35	50	55	75	75, 100, 125, 150, 200, 250	桥式/封闭	66	24	26	65	78	14	8
	35	60	55	85		桥式				75	88		
	35	75	55	100		桥式/封闭				90	103		
	35	100	55	125		桥式/封闭				115	128		
	35	125	55	150		桥式/封闭				140	153		
	35	150	55	175		桥式				165	178		
	35	175	55	200		桥式				190	203		
	35	200	55	225		桥式				215	228		
	35	250	55	275		桥式				265	278		

## H40 黄点加强型系列



可根据客户要求  
进行配色生产

接头安装尺寸图

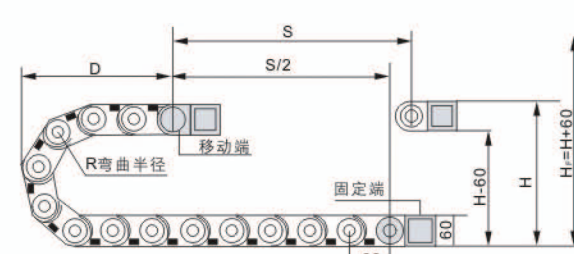

主要技术参数

节距=66mm, 不含接头每米节数=15, 链长=S/2+K, S=行程距离, K=π·R+“安全量”

R	75	100	125	150	200	250
H	210	260	310	360	460	560
D	171	196	221	246	296	346
K	396	475	553	632	789	946

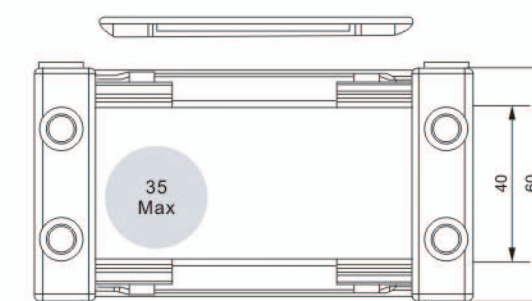
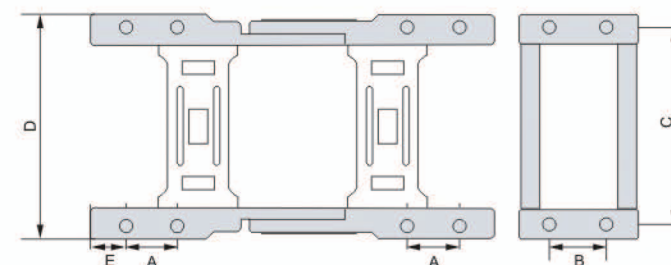

技术参数表

系列号	内高	内宽	外高	外宽	弯曲半径(R)	打开方式	节距	A	B	C	D	E	孔径
H40系列	40	50	60	73	75, 100	桥式/封闭	66	24	26	65	78	16	8
	40	60	60	83		桥式				75	88		
	40	75	60	98		桥式/封闭				90	103		
	40	100	60	123	125, 150	桥式/封闭				115	128		
	40	125	60	148		桥式/封闭				140	153		
	40	150	60	173	200, 250	桥式				165	178		
	40	175	60	198		桥式				190	203		
	40	200	60	223		桥式				215	228		
	40	250	60	273	桥式	265				278			

# H45 黄点加强型系列



接头安装尺寸图

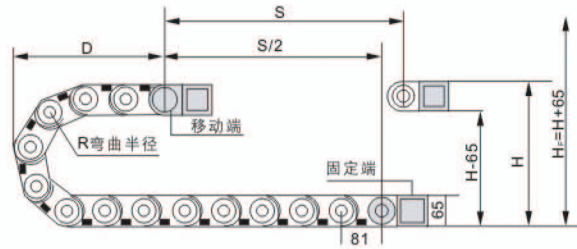

主要技术参数

节距=81mm, 不含接头每米节数=13, 链长=S/2+K, S=行程距离, K=π·R+“安全量”

R	75	100	125	150	175	200	250
H	215	265	315	365	415	465	565
D	189	214	239	264	289	314	364
K	419	498	576	655	733	812	969

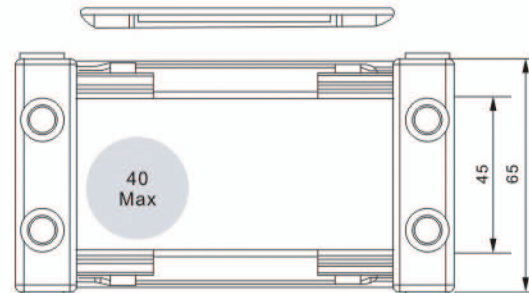
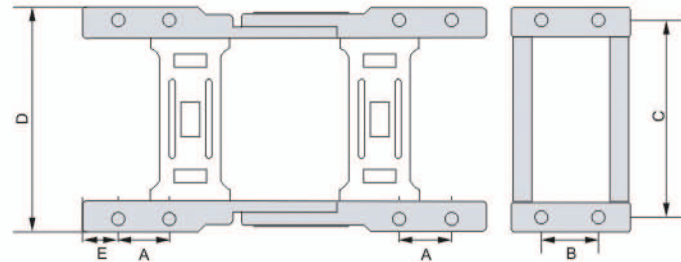

技术参数表

系列号	内高	内宽	外高	外宽	弯曲半径(R)	打开方式	节距	A	B	C	D	E	孔径
H45系列	45	50	65	80	75, 100 125, 150 175, 200 250	桥式	81	24	26	68	83	16	8
	45	60	65	90		桥式				78	93		
	45	75	65	105		桥式/封闭				93	108		
	45	100	65	130		桥式/封闭				118	133		
	45	125	65	155		桥式/封闭				143	158		
	45	150	65	180		桥式/封闭				168	183		
	45	175	65	205		桥式				193	208		
	45	200	65	230		桥式				218	233		
	45	250	65	280		桥式				268	283		

# H55 黄点加强型系列



接头安装尺寸图

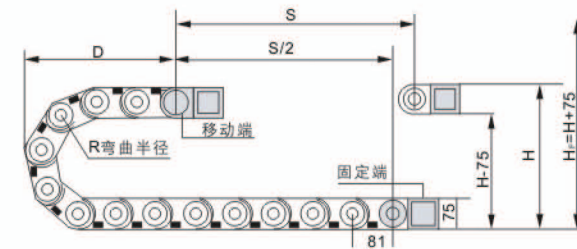

主要技术参数

节距=81mm, 不含接头每米节数=12, 链长=S/2+K, S=行程距离, K=π·R+“安全量”

R	75	100	125	150	200	250	300	400	500
H	225	275	325	375	475	575	675	875	1075
D	194	219	244	269	319	369	419	519	619
K	435	513	592	670	827	984	1141	1455	1769

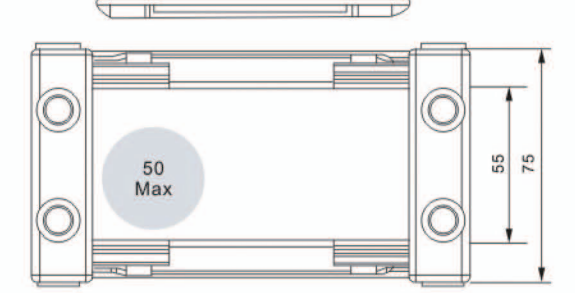
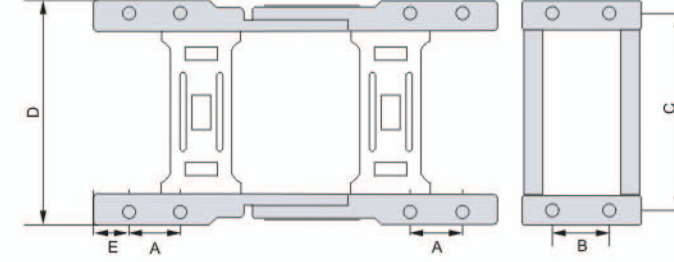

技术参数表

系列号	内高	内宽	外高	外宽	弯曲半径(R)	打开方式	节距	A	B	C	D	E	孔径(φ)
H55系列	55	50	75	77	75, 100 125, 150 200, 250 300, 400 500	桥式	81	24	38	68	83	18	8
	55	60	75	87		桥式				78	93		
	55	75	75	102		桥式/封闭				93	108		
	55	100	75	127		桥式/封闭				118	133		
	55	125	75	152		桥式/封闭				143	158		
	55	150	75	177		桥式/封闭				168	183		
	55	175	75	202		桥式				193	208		
	55	200	75	227		桥式				218	233		
	55	250	75	277		桥式				268	283		



# H60 黄点加强型系列



## 接头安装尺寸图

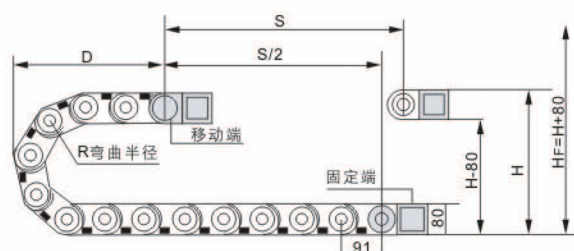

## 主要技术参数

节距=91mm, 不含接头每米节数=11, 链长=S/2+K, S=行程距离, K=π·R+"安全量"

R	125	150	200	250	300	400	500
H	330	380	480	580	680	880	1080
D	256	281	331	381	431	531	631
K	610	688	845	1002	1159	1473	1787

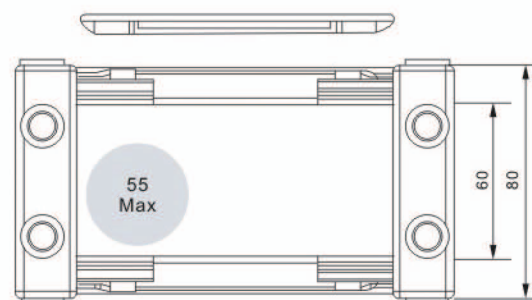
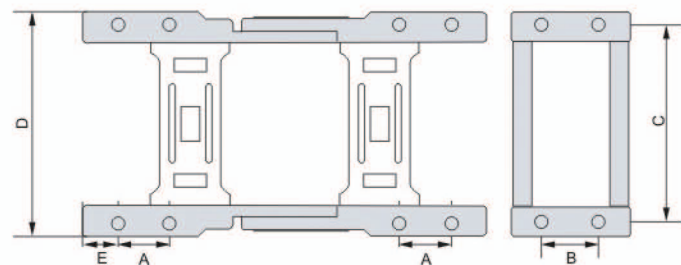

## 技术参数表

系列号	内高	内宽	外高	外宽	弯曲半径(R)	打开方式	节距	A	B	C	D	E	孔径
H60系列	60	50	80	81	125, 150	桥式	91	30	42	72	87	16	8
	60	60	80	91		桥式				82	97		
	60	75	80	106		桥式/封闭				97	112		
	60	100	80	131	200, 250	桥式/封闭				122	137		
	60	125	80	156	300, 400	桥式/封闭				147	162		
	60	150	80	181		桥式/封闭				172	187		
	60	175	80	206		桥式/封闭				197	212		
	60	200	80	231	500	桥式				222	237		
	60	250	80	281		桥式				272	287		

# H65 黄点加强型系列



## 接头安装尺寸图

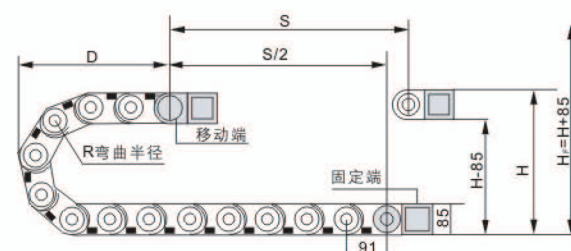

## 主要技术参数

节距=91mm, 不含接头每米节数=11, 链长=S/2+K, S=行程距离, K=π·R+"安全量"

R	125	150	200	250	300	400	500
H	335	385	485	585	685	885	1085
D	259	284	334	384	434	534	634
K	617	696	853	1010	1167	1481	1795

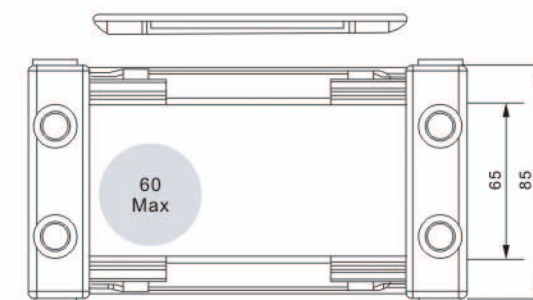
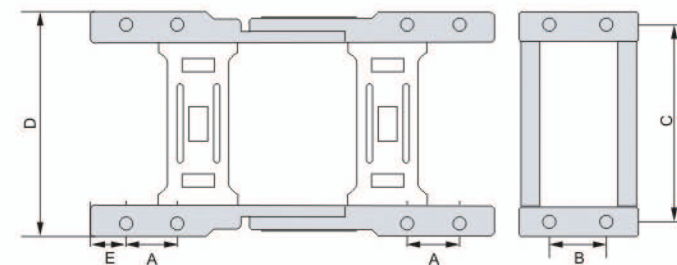

## 技术参数表

系列号	内高	内宽	外高	外宽	弯曲半径(R)	打开方式	节距	A	B	C	D	E	孔径
H65系列	65	50	85	81	125, 150	桥式	91	27	46	73	89	18	12
	65	60	85	91		桥式				83	99		
	65	75	85	106		桥式/封闭				98	114		
	65	100	85	131	200, 250	桥式/封闭				123	139		
	65	125	85	156	300, 400, 500	桥式/封闭				148	164		
	65	150	85	181		桥式/封闭				173	189		
	65	175	85	206		桥式/封闭				198	214		
	65	200	85	231	500	桥式/封闭				223	239		
	65	250	85	281		桥式				273	289		

## HS 黄点加强型系列



HS黄点加强型塑料拖链是专门为在特殊场合下运动的电缆所制造，可做双向的二维运动，每节为整体封闭型，可自由拆卸，长度可根据客户要求任意选择。

注：其它型号可来电咨询。

公司现有型号：

**HS25** **HS35** **HS45**

其内径外径尺寸参考H黄点加强型。

## 拓展型系列

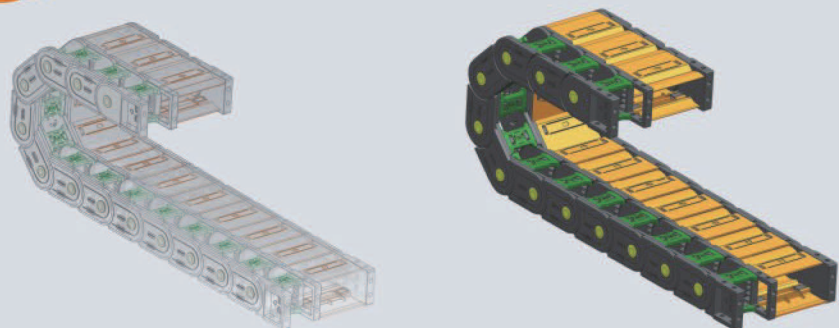

### 拓展型列表

系列号	弯曲半径(R)	打开方式
H25	55, 75, 100, 125, 150, 175	桥式/封闭
H30	55, 75, 100, 125, 150, 175	
H35	75, 100, 125, 150, 200, 250	
H40	75, 100, 125, 150, 200, 250	
H45	75, 100, 125, 150, 175, 200, 250	
H55	75, 100, 125, 150, 200, 250, 300, 400, 500	
H60	125, 150, 200, 250, 300, 400, 500	
H65	125, 150, 200, 250, 300, 400, 500	
H80	150, 200, 250, 300, 350, 400, 450, 500, 550, 600	
H100	150, 200, 250, 300, 350, 400, 450, 500, 550, 600	











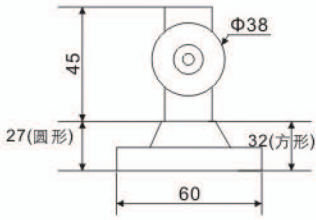

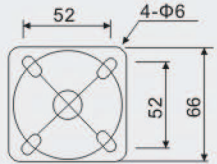
**金角兽**  
JIN JIAO SHOU  
气动 工控 电气

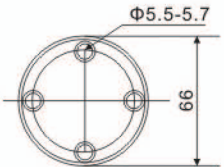

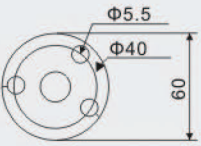
# 报警灯底座选型及尺寸图

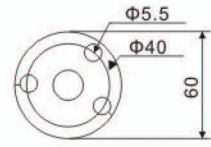
Alarm lamp base selection and size chart

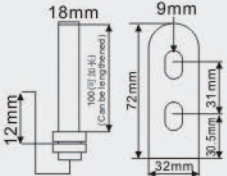
底座样式图 Base style drawing	安装尺寸 Installation dimensions
 <p>B型折叠 圆形三孔底座</p>	 <p>Φ38 45 27(圆形) 32(方形) 60</p>
 <p>B型折叠 方形四孔底座</p>	 <p>52 4-Φ6 52 66</p>
 <p>B型折叠 圆形四孔底座</p>	 <p>Φ5.5-5.7 66</p>
 <p>F型圆座 折叠加长底座</p>	 <p>Φ5.5 Φ40 60</p>
 <p>Q型 铝杆圆底座</p>	 <p>Φ5.5 Φ40 60</p>
 <p>L型 铝杆侧装底座</p>	 <p>18mm 9mm 12mm 72mm 31mm 32mm 30.5mm</p>

# TP系列新款一层三色LED警示灯

TP series new layer three-color LED warning light



## 产品描述 Product description

- ◇内置超高品质贴片LED光源, 寿命长、节能、高亮度
- ◇安装方式: 折叠加长式、杆盘式、侧装式
- ◇闪光频率: 60-80/min
- ◇蜂鸣音量: 85-110/dB
- ◇主要材料: 灯罩-PC
- ◇防护等级: IP50
- ◇技术认证: CE
- ◇使用范围: 自动化设备、流水线、机床设备、纺织机械、陶瓷加工设备、安检设备、电子机械、报警系统等
- ◇Built in high quality LED light source, long life, energy saving, high brightness
- ◇Installation methods: bending, rod bending, rod disc
- ◇L rod type Flash frequency: 60-80/min
- ◇Buzzer volume: 85-110/dB
- ◇Main material: lampshade-PC
- ◇Protection level: IP50
- ◇Technology certification: CE
- ◇Scope of application: automation equipment, assembly lines, machine tool equipment, textile machinery, alarm system, etc.

## 产品接线方式 Product wiring mode

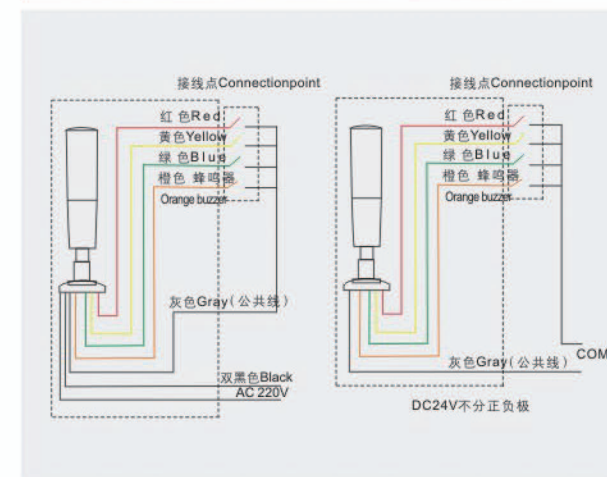

## 型号及其含义 Model extremely meaning

型号 Model	电压/Voltage	颜色 Color
TP01-3T-J+F (TP02) (TP03)	DC12V	<span style="color:red">■</span> 红 (Red) <span style="color:yellow">■</span> 黄 (Yellow) <span style="color:green">■</span> 绿 (Green)
	DC24V	
	AC110V	
	AC220V	



## 产品外形图 Product outing drawing

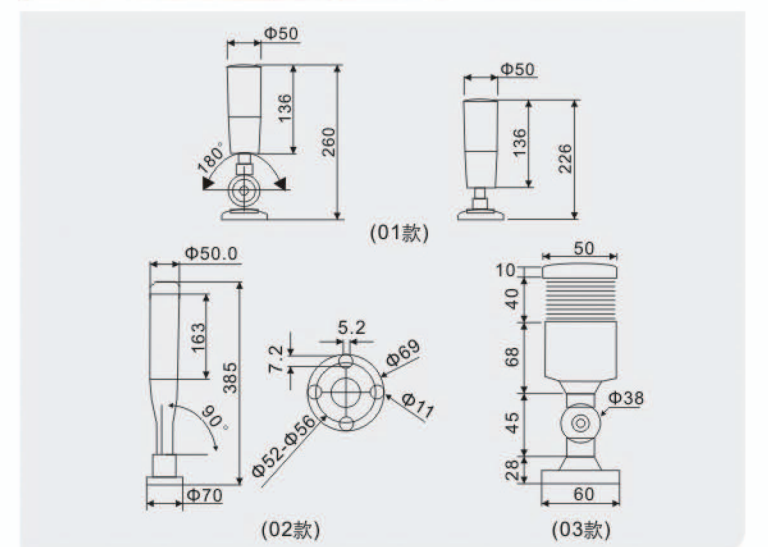

# TW系列白色多层式LED警示灯

TW series white multilayer led warning light



## 产品描述 Product description

- ◇内置超高品质贴片LED光源,寿命长、节能、高亮度
- ◇安装方式: 折叠式、折叠加长式、杆盘式、侧装式、桶式
- ◇闪光频率: 60-80/min
- ◇蜂鸣音量: 85-110/dB
- ◇主要材料: 灯罩-PC, 底座-ABS
- ◇防护等级: IP30
- ◇技术认证: CE
- ◇使用范围: 自动化设备、流水线、机床设备、纺织机械、陶瓷加工设备、安检设备、电子机械、报警系统等

- ◇Built in high quality LED light source, long life, energy saving, high brightness
- ◇Installation methods: bending, rod bending, rod disc
- ◇L rod type Flash frequency: 60-80/min
- ◇Buzzer volume: 85-110/dB
- ◇Main material: Lampshade-PC, base-ABS
- ◇Protection level: IP30
- ◇Technology certification: CE
- ◇Scope of application: automation equipment, assembly lines, machine tool equipment, textile machinery, alarm system, etc.

## 产品接线方式 Product wiring mode

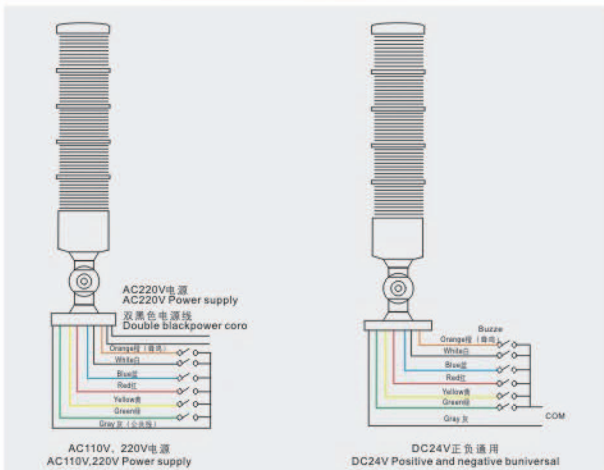

## 型号及其含义 Model extremely meaning

型号Model	电压/Voltage	颜色Color
TW50-3T-J+B	DC12V	红(Red)
	DC24V	黄(Yellow)
	AC110V	绿(Green)
	AC220V	蓝(Blue)
		白(White)

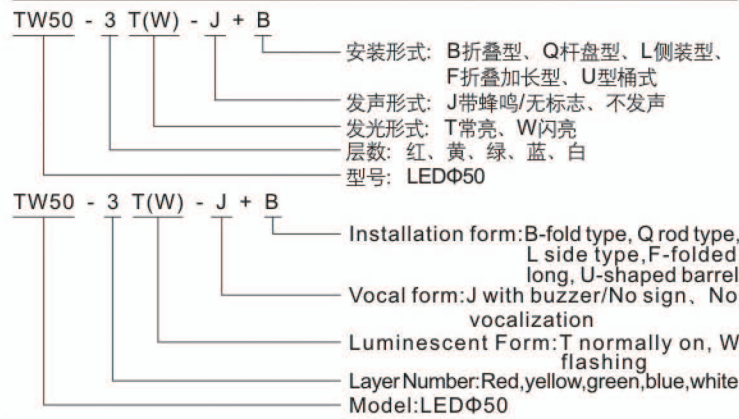

## 产品外形图 Product outing drawing

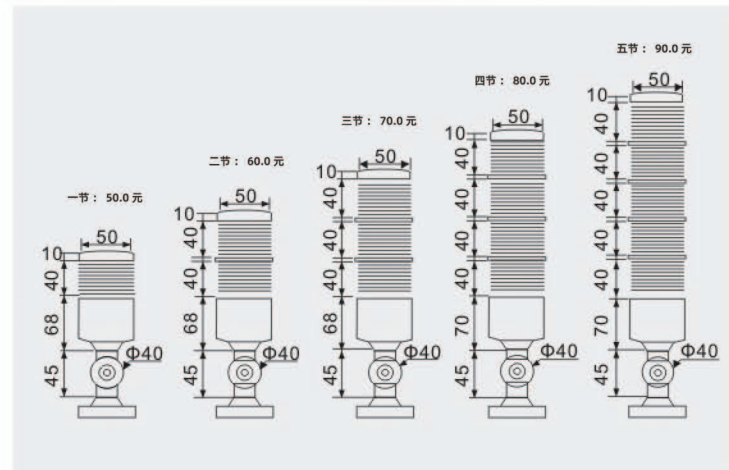

# TB系列黑色多层式LED警示灯

TB series black multilayer led warning light



## 产品描述 Product description

- ◇内置超高品质贴片LED光源,寿命长、节能、高亮度
- ◇安装方式: 折叠式、折叠加长式、杆盘式、侧装式、桶式
- ◇闪光频率: 60-80/min
- ◇蜂鸣音量: 85-110/dB
- ◇主要材料: 灯罩-PC, 底座-ABS
- ◇防护等级: IP30
- ◇技术认证: CE
- ◇使用范围: 自动化设备、流水线、机床设备、纺织机械、陶瓷加工设备、安检设备、电子机械、报警系统等

- ◇Built in high quality LED light source, long life, energy saving, high brightness
- ◇Installation methods: bending, rod bending, rod disc
- ◇Buzzer volume: 85-110/dB
- ◇Main material: Lampshade-PC, base-ABS
- ◇Protection level: IP30
- ◇Technology certification: CE
- ◇Scope of application: automation equipment, assembly lines, machine tool equipment, textile machinery, alarm system, etc.

## 产品接线方式 Product wiring mode

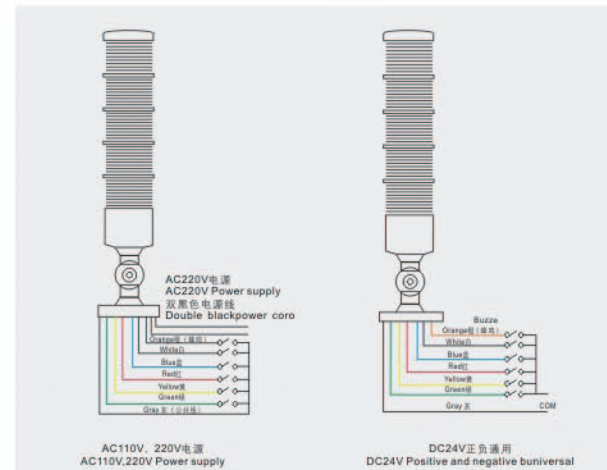

## 型号及其含义 Model extremely meaning

型号Model	电压/Voltage	颜色Color
TB50-3T-J+B	DC12V	红(Red)
	DC24V	黄(Yellow)
	AC110V	绿(Green)
	AC220V	蓝(Blue)
		白(White)

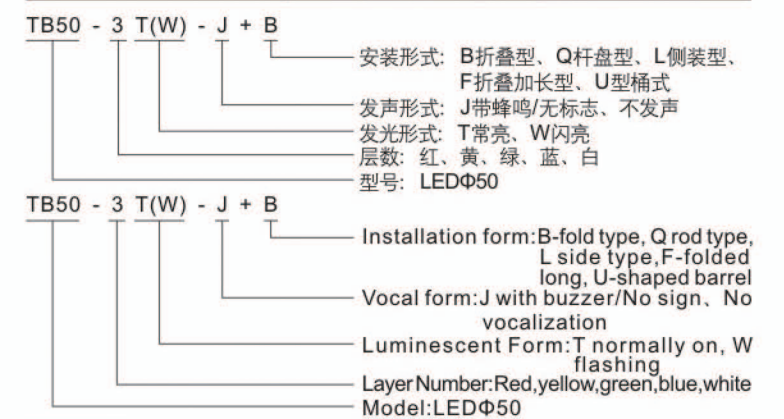

## 产品外形图 Product outing drawing

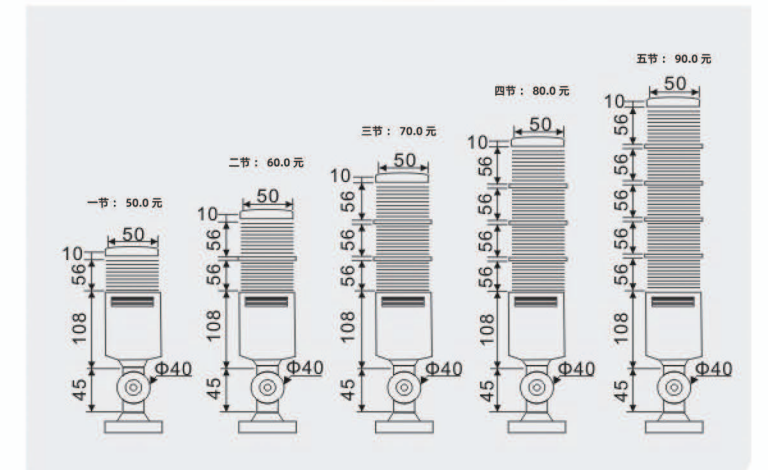

## D-2071系列小型闪屏LED警示灯

D-2071 Series Small Strobe LED Warning Light



### 产品描述 Product description

- ◇内置超高品质贴片LED光源, 寿命长、节能、高亮度
- ◇安装方式: 螺丝、磁铁
- ◇闪光频率: 60-80/min
- ◇蜂鸣音量: 85-110/dB
- ◇主要材料: 灯罩-PC, 底座-ABS
- ◇防护等级: IP30
- ◇技术认证: CE
- ◇使用范围: 自动化设备、流水线、机床设备、纺织机械、陶瓷加工设备、安检设备、电子机械、报警系统等
- ◇Built-in ultra-high quality LED light source, long life, energy saving, high brightness
- ◇Installation method: screw, magnet
- ◇Flash frequency: 60-80/min
- ◇Beep volume: 85-110/dB
- ◇Main materials: lampshade-PC, base-ABS
- ◇Protection level: IP30
- ◇Technical certification: CE
- ◇Scope of use: automation equipment, assembly lines, machine tools, textile machinery, ceramic processing equipment, security equipment, electronic machinery, alarm system, etc.

### 型号及其含义 Model extremely meaning

型号Model	电压/Voltage	颜色Color
D-2071-J-R	DC12V	
	DC24V	
	AC110V	
	AC220V	
	AC380V	

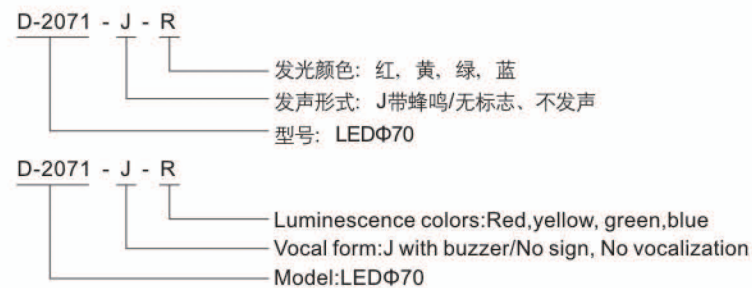

### 产品外形图 Product outing drawing

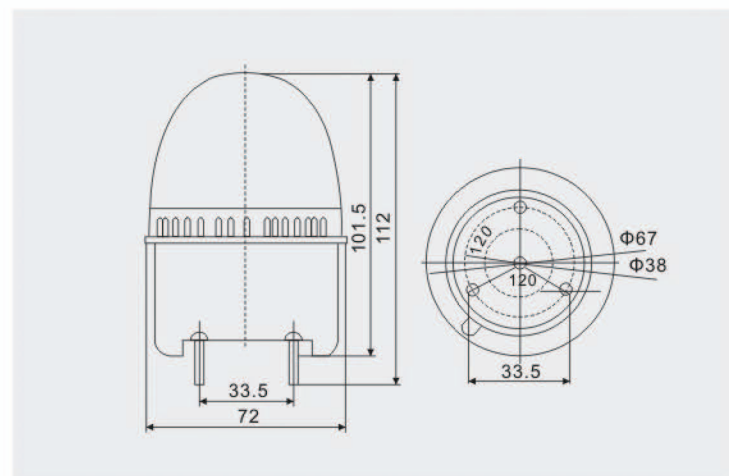

## D-1081系列电子旋转LED警示灯

D-1081 Series Electronic Rotating LED Warning Light



### 产品描述 Product description

- ◇内置超高品质LED光源, 寿命长、节能、高亮度
- ◇安装方式: 螺丝、磁铁
- ◇闪光频率: 60-80/min
- ◇蜂鸣音量: 85-110/dB
- ◇主要材料: 灯罩-PC, 底座-ABS
- ◇防护等级: IP30
- ◇技术认证: CE
- ◇使用范围: 自动化设备、流水线、机床设备、纺织机械、陶瓷加工设备、安检设备、电子机械、报警系统等
- ◇Built-in ultra-high quality LED light source, long life, energy saving, high brightness
- ◇Installation method: screw, magnet
- ◇Flash frequency: 60-80/min
- ◇Beep volume: 85-110/dB
- ◇Main materials: lampshade-PC, base-ABS
- ◇Protection level: IP30
- ◇Technical certification: CE
- ◇Scope of use: automation equipment, assembly lines, machine tools, textile machinery, ceramic processing equipment, security equipment, electronic machinery, alarm system, etc.

### 型号及其含义 Model extremely meaning

型号Model	电压/Voltage	颜色Color
D-1081-J-R	DC12V	
	DC24V	
	AC110V	
	AC220V	
	AC380V	



### 产品外形图 Product outing drawing

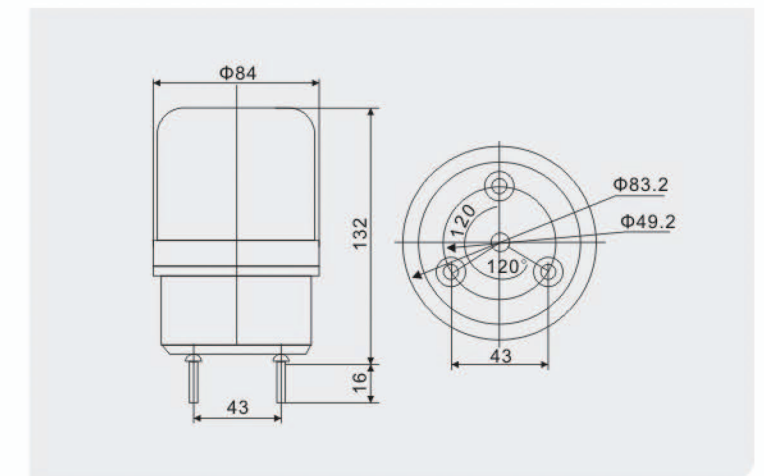

# D-1101系列电子旋转LED警示灯

## D-1101 Series Electronic Rotating LED Warning Light



### 产品描述 Product description

- ◇内置超高品质贴片LED光源,寿命长、节能、高亮度
- ◇安装方式: 螺丝、磁铁
- ◇闪光频率: 60-80/min
- ◇蜂鸣音量: 85-110/dB
- ◇主要材料: 灯罩-PC、底座-ABS
- ◇防护等级: IP30
- ◇技术认证: CE
- ◇使用范围: 自动化设备、流水线、机床设备、纺织机械、陶瓷加工设备、安检设备、电子机械、报警系统等
- ◇Built-in ultra-high quality LED light source,long life, energy saving,high brightness
- ◇Installation method:screw,magnet
- ◇Flash frequency:60-80/min
- ◇Beep volume:85-110/dB
- ◇Main materials:lampshade-PC,base-ABS
- ◇Protection level:IP30
- ◇Technical certification:CE
- ◇Scope of use:automation equipment,assembly lines, machine tools,textile machinery,ceramic processing equipment,security equipment,electronic machinery, alarm systems,etc.

### 型号及其含义 Model extremely meaning

型号Model	电压/Voltage	颜色Color
D-1101-J-R	DC12V	
	DC24V	
	AC110V	
	AC220V	
	AC380V	

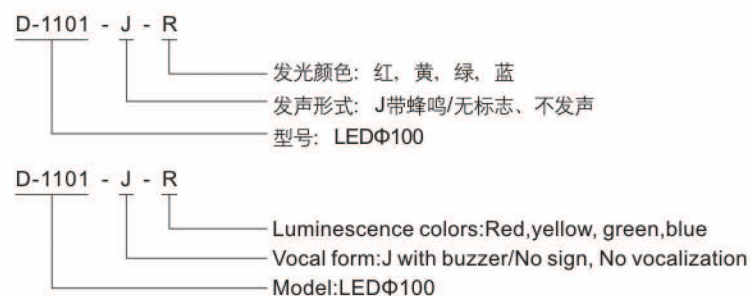



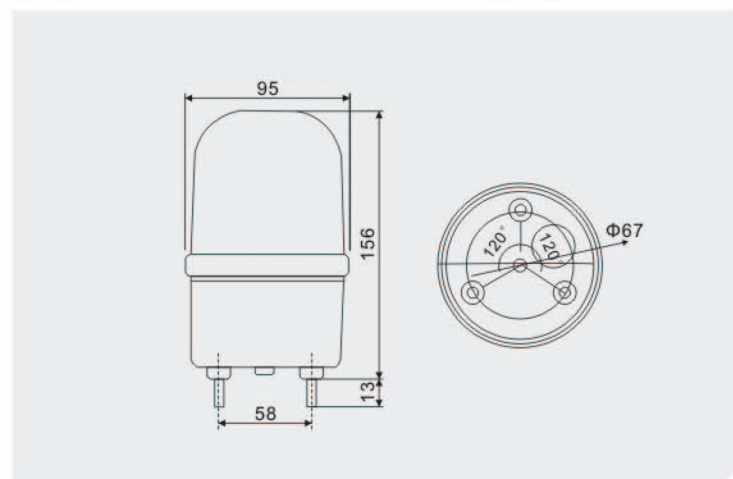



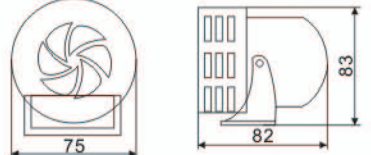

### 产品外形图 Product outing drawing

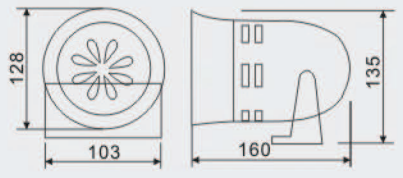

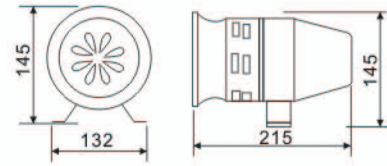
产品图 Product picture	型号 Model	工作电压 Operating Voltage	外形图 Outline
	D-3051 D-3051-J	DC12V DC24V AC110V AC220V	
	D-2071C D-2071C-J	DC12V DC24V AC110V AC220V	
	磁铁式 D-1081C D-1081C-J	DC12V DC24V AC110V AC220V	
	D-1101C D-1101C-J	DC12V DC24V AC110V AC220V	
	D-80-TYN D-80C-TYN	太阳能	
	D-1101 D-1101-J 断电报警	AC220V AC380V	
	D-1101 D-1101-J 充电式	DC12V	

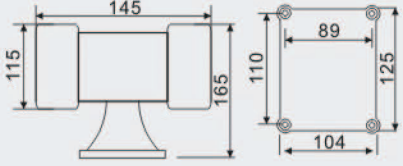
产品图 Product picture	型号 Model	工作电压 Operating Voltage	外形图 Outline
	D-6188	DC12V DC24V AC110V AC220V	
	D-6388	DC12V DC24V AC110V AC220V	
	PJ-2060	DC12V DC24V AC110V AC220V	
	PJ-2060-J	DC12V DC24V AC110V AC220V	
	PB-10J	DC12V DC24V AC110V AC220V	
	PB-20J	DC12V DC24V AC110V AC220V	

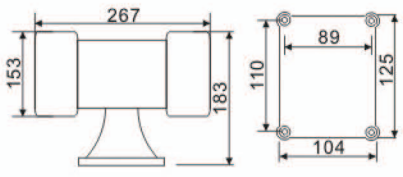
产品图 Product picture	型号 Model	工作电压 Operating Voltage	外形图 Outline
	MS190	DC12V DC24V AC110V AC220V	
	MS290	DC12V DC24V AC110V AC220V	
	MS390	DC12V DC24V AC110V AC220V	
	MS490	AC110V AC220V	
	MS590	AC110V AC220V	

6外卡式（出口型）R15			7桥式不可打开R15 R28				
内径	6*10	0	内径	7*7			
外径	9*15		外径	10*14			
单价	16.8		单价	16.8			
10桥式不可打开系列弯曲半径R18R28 R38							
内径	10*10	10*15	10*20	10*30			
外径	15*18	15*23	15*28	15*38			
单价	16.8	19.2	21.6	24			
15半封闭内开系列弯曲半径R28 R38 R48							
内径	15*15	15*20	15*30	15*40	15*50		
外径	20*25	20*30	20*40	20*50	20*60		
单价	43.2	21.6	24	27	28.8		
18半封闭内开系列弯曲半径R38 R48 R60							
内径	18*18	18*25	18*37	18*50			
外径	23*24	23*36	23*47	23*60			
单价	24		28.8	31.2			
S25静音指链系列弯曲半径R55R75R100							
内径	25*25	25*38	25*50	25*57	25*77		
外径	36*43	36*56	36*68	36*75	36*95		
单价	57.6	60	62.4	64.8	69.6		
T25黑休经济型系列弯曲半径 R40 R55 R75 R100 R125 R150 R175							
内径	25*25	25*38	25*50	25*57	25*60	25*77	25*103
外径	36*40	36*53	36*65	36*72	36*75	36*92	36*118
桥式单价	91.6	40.8	45.6	50.4	51.8	55.2	60
全封单价		51	55.2	60	62.4	64.8	
H20黄点加强型系列弯曲半径 R55 R75 R100 R125 R150 R175							
内径	25*25	25*38	25*50	25*57	25*60	25*77	25*103
外径	35*43	35*56	35*68	35*75	35*78	35*95	35*121
桥式单价	43.2	45.6	48	50	52.6	54.8	64
全封单价		55.2	60	64.8	67.2	69.6	
H25黄点加强型系列弯曲半径R55R75 R100 R125 R150 R175							
内径	25*25	25*38	25*50	25*57	25*60	25*77	25*103
外径	40*43	40*56	40*68	40*75	40*78	40*95	40*121
桥式单价	24	25	26.2	27.4	28.5	29.7	34.2
全封价		60	68.8	67.2	72	76.8	

H30黄点加强型系列弯曲半径R55R75R100R125R150R175									
内径	30*25	30*38	30*50	30*57	30*60	30*77	30*103		
外径	45*43	45*56	45*68	45*75	45*78	45*95	45*121		
桥式单价	52.4	54.8	57	59.4	61.6	64	73		
全封单价		64.8	69.6	72	76.8	41.6			
H35黄点加强型系列弯曲半径R75R100R125R150R200 R250									
内径	35*50	35*60	35*75	35*100	35*125	35*150	35*200	35*250	
外径	55*75	55*85	55*100	55*125	55*150	55*175	55*225	55*275	
桥式单价	77.6	80	84.2	91.2	98	105	118.6	132.4	
全封单价	88.4		100.8	108	120				
H40黄点加强型系列弯曲半径R75 R100 R125 R150 R200 R250									
内径	40*50	40*60	40*75	40*100	40*125	40*150	40*200	40*250	
外径	60*73	60*83	60*98	60*123	60*148	60*173	60*223	60*273	
桥式单价	89	91.2	95.8	102.6	109.4	116.4	130	141.4	
全封单价	105.6		115.2	120	132				
H45黄点加强型系列弯曲半径R100 R125 R150R175 R200 R250									
内径	45*50	45*60	45*75	45*100	45*125	45*150	45*200	45*250	
外径	65*80	65*90	65*105	65*130	65*155	65*180	65*130	65*180	
桥式单价	95.8	98	100.4	102.6	107.2	114	135.4	136.8	
全全单价			120	132	144	156			
H55黄点加强型系列弯 H 半径 R125 R150 R200									
内径	55*50	55*60	55*75	55*100	55*125	55*150	55*200	55*250	
外径	75*77	75*87	75*102	75*127	75*152	75*177	75*227	75*277	
桥式单价	114	116	118.6	125.4	130	136.8	148.2	159.6	
全封单价			146.4	158.4	136.8	184.8			
H60黄点加强型系列弯曲半径R125R150 R200 R250 R300 R400 R500									
内径	60*50	60*60	60*75	60*100	60*125	60*150	60*175	60*200	60*250
外径	80*81	80*91	80*106	80*131	80*156	80*181	80*206	80*231	80*281
桥式单价	132.2	139	143.6	148.2	152.8	157.4		166.4	175.6
全封单价			175.2	187.2	199.2	211.2	223.2	231.2	
H65黄点加嘔型系列弯曲半径R125R150 R200 R250 R300 R400 R500									
内径	65*50	65*60	65*75	65*100	65*125	65*150	65*175	65*200	65*250
外径	85*81	85*91	85*106	85*131	85*156	85*181	85*206	85*231	85*281
桥式单价	139	144	148.2	152.8	157.4	164		175.6	187
全封单价			180	196.8	213.6	230.4	242.4	259.2	





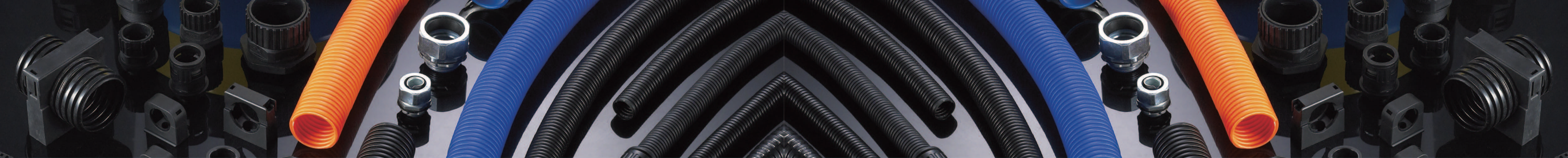



产品名称	规格	尺寸 (内径*外径)	单价	包装 (米/卷)	每卷 (长*宽*高)
PE 波纹管	AD7	4.5*7	0.80	200	38*38*15
	AD10	7*10	0.76	100	35*35*14
	AD13	10*13	0.80	100	42*42*15
	AD15.8	12*15.8	0.90	100	46*46*17
	AD18.5	14.3*18.5	1.10	100	53*53*18
	AD21.2	17*21.2	1.20	100	58*58*21
	AD25	21*25	1.70	100	62*62*22
	AD28.5	23*28.5	2.20	50	52*52*22
	AD34.5	29*34.5	2.80	50	60*60*22
	AD42.5	36*42.5	4.40	50	77*77*23
	AD54.5	48*54.5	7.60	25	75*75*23
	AD67.2	56*67.2	44.00	25	
	AD80	69*80	56.00	25	
	AD106	91*106	72.00	20	
PP 波纹管	AD7	4.5*7	0.90	200	38*38*15
	AD10	7*10	1.00	100	35*35*14
	AD12	9*12	1.00	200	45*45*15
	AD13	10*13	1.20	100	42*42*15
	AD15.8	12*15.8	1.40	100	46*46*17
	AD18.5	14.3*18.5	1.60	100	53*53*18
	AD21.2	17*21.2	2.00	100	58*58*21
	AD25	21*25	2.40	100	62*62*22
	AD28.5	23*28.5	3.20	50	52*52*22
	AD34.5	29*34.5	3.60	50	60*60*22
	AD42.5	36*42.5	5.80	50	77*77*23
	AD54.5	48*54.5	10.00	25	75*75*23
	AD67.2	56*67.2	60.00	25	
	AD80	69*80	76.00	25	
AD106	91*106	82.00	20		
PA 波纹管	AD7	4.5*7	4.80	200	38*38*15
	AD10	7*10	2.40	100	35*35*14
	AD13	10*13	2.60	100	42*42*15
	AD15.8	12*15.8	3.80	100	46*46*17
	AD18.5	14.3*18.5	4.60	100	53*53*18
	AD21.2	17*21.2	5.40	100	58*58*21
	AD25	21*25	6.40	100	62*62*22
	AD28.5	23*28.5	7.60	50	52*52*22
	AD34.5	29*34.5	11.20	50	60*60*22
	AD42.5	36*42.5	16.00	50	77*77*23
	AD54.5	48*54.5	22.00	25	75*75*23
	AD67.2	56*67.2	80.00	25	
	AD80	69*80	100.00	25	
	AD106	91*106	120.00	20	

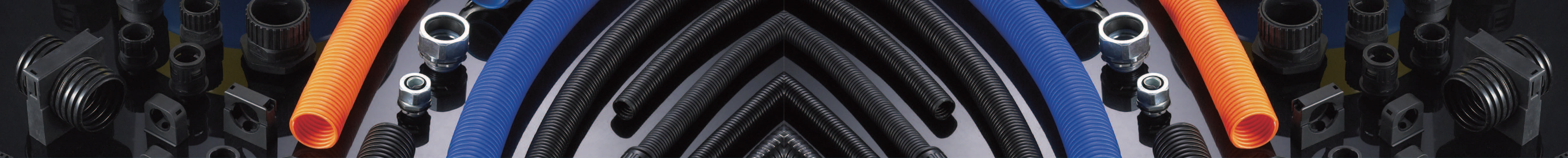

产品名称	AD 适配软管	螺纹规格公制	单价元/只	包装只/包
软管接头	AD10	M10*1.5	1.26	100
	AD10	M12*1.5	1.26	100
	AD10	M16*1.5	1.26	100
	AD13	M12*1.5	1.38	100
	AD13	M16*1.5	1.38	100
	AD13	M18*1.5	1.38	100
	AD13	M20*1.5	1.38	100
	AD15.8	M16*1.5	1.60	100
	AD15.8	M18*1.5	1.60	100
	AD15.8	M20*1.5	1.60	100
	AD18.5	M20*1.5	1.84	50
	AD21.2	M20*1.5	2.06	50
	AD21.2	M24*1.5	2.06	50
	AD21.2	M25*1.5	2.06	50
	AD25	M25*1.5	2.30	50
	AD28.5	M25*1.5	2.52	50
	AD28.5	M27*1.5	2.52	50
	AD28.5	M30*1.5	2.52	50
	AD34.5	M32*1.5	3.22	20
	AD34.5	M36*1.5	3.22	20
	AD42.5	M40*1.5	4.36	10
	AD42.5	M48*1.5	4.36	10
	AD54.5	M50*1.5	8.28	10
	AD54.5	M60*1.5	8.28	10
	AD54.5	M63*1.5	8.28	10

产品名称	AD 适配软管	螺纹规格德制	单价元/只	包装只/包
软管接头	AD10	PG7	1.10	100
	AD13	PG9	1.20	100
	AD15.8	PG11	1.40	100
	AD18.5	PG13.5	1.60	50
	AD21.2	PG16	1.80	50
	AD25		2.00	50
	AD28.5	PG21	2.20	50
	AD34.5	PG29	2.80	20
	AD42.5	PG36	3.80	10
	AD54.5	PG48	7.20	10

产品名称	AD 适配软管	螺纹规格德制	单价元/只	包装只/包
固定支架	AD10	PG7	1.36	100
	AD13	PG9	1.52	100
	AD15.8	PG11	1.80	100
	AD18.5	PG13.5	2.00	100
	AD21.2	PG16	2.20	100
	AD25		2.60	100
	AD28.5	PG21	2.70	50
	AD34.5	PG29	2.90	50
	AD42.5	PG36	3.20	50
	AD54.5	PG48	4.20	25



产品名称	AD 适配软管	螺纹规格公制	单价元 / 只	包装只 / 包
快速接头 	AD10	M12*1.5	1.16	100
	AD13	M16*1.5	1.36	100
	AD15.8	M16*1.5	1.58	100
	AD15.8	M18*1.5	1.58	100
	AD18.5	M20*1.5	1.70	50
	AD21.2	M20*1.5	2.10	50
	AD21.2	M24*1.5	2.10	50
	AD25	M25*1.5	2.30	50
	AD28.5	M25*1.5	2.50	50
	AD28.5	M27*2.0	2.50	50
	AD28.5	M30*2.0	2.50	50
	AD34.5	M32*1.5	3.80	20
	AD34.5	M36*2.0	3.80	20
	AD42.5	M48*2.0	4.80	10
	AD54.5	M60*2.0	7.20	10
快速接头 	AD10	PG7	1.16	100
	AD13	PG9	1.36	100
	AD15.8	PG11	1.58	100
	AD18.5	PG13.5	1.70	50
	AD21.2	PG16	2.10	50
	AD25		2.30	50
	AD28.5	PG21	2.50	50
	AD34.5	PG29	3.80	20
	AD42.5	PG36	4.80	10
	AD54.5	PG48	7.20	10

产品名称	规格	单价	包装
尼龙接头 	Φ8	0.42	200 只
	Φ10	0.42	100 只
	Φ13	0.42	100 只
	Φ16	0.62	100 只
	Φ20	0.70	50 只
	Φ25	1.26	50 只
	Φ32	1.68	40 只
	Φ38	3.00	25 只
	Φ51	7.20	10 只
	Φ64	11.40	5 只
防水接头 	PG7	0.40	100 只
	PG9	0.48	100 只
	PG11	0.60	100 只
	PG13.5	0.66	100 只
	PG16	0.88	100 只
	PG19	1.10	100 只
	PG21	1.32	100 只
	PG25	1.76	100 只
	PG29	2.40	50 只
	PG36	4.40	50 只

产品名称	AD 适配软管	螺纹规格德制	单价元 / 只	包装只 / 包
直角弯头 	AD10	PG7	3.08	100
	AD13	PG9	3.30	100
	AD15.8	PG11	3.74	100
	AD18.5	PG13.5	4.18	50
	AD21.2	PG16	4.62	50
	AD25		5.06	50
	AD28.5	PG21	5.72	50
	AD34.5	PG29	7.92	20
	AD42.5	PG36	11.00	10
	AD54.5	PG48	16.50	10

品名	规格	带钢宽度	带钢厚度	单价 (不包塑)	单价 (包塑)	包装 (米)
金属软管 	Φ8	6	0.20	2.52	2.94	200
	Φ10	6.5	0.20	2.52	3.08	100
	Φ12	7.1	0.20	2.52	3.38	100
	Φ16	8.6	0.20	2.90	4.12	50
	Φ20	8.6	0.22	3.70	4.96	50
	Φ25	9.5	0.25	4.32	6.10	30
	Φ32	12.7	0.25	7.14	9.82	30
	Φ38	15	0.30	11.14	14.12	20
	Φ51	17	0.35	16.18	23.84	20
	Φ64	21.2	0.60	33.60	56.20	20
	Φ75	21.2	0.60	46.20	92.00	10
	Φ100	21.2	0.60	61.74	130.00	10

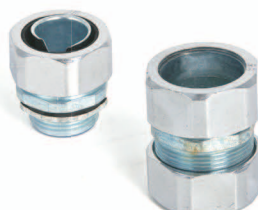
产品名称	规格	端接式	卡套式	自固式	90° 弯头
金属软管接头系列 	Φ8	3.08			
	Φ10	3.08			
	Φ12	3.74	3.74	5.94	7.20
	Φ16	4.84	4.84	6.38	9.20
	Φ20	6.38	6.38	7.70	12.54
	Φ25	9.24	9.24	11.20	20.40
	Φ32	13.64	13.64	16.90	28.20
	Φ38	18.26	18.26	23.30	37.00
	Φ51	29.48	29.48	35.00	56.00
	Φ64	50.16	50.16	61.80	114.00
	Φ75	66.00	66.00	80.00	159.00
	Φ100	121.00	121.00	148.00	308.00

产品名称	规格	尺寸 (内径 * 外径)	单价	包装 (米 / 卷)	每卷 (长 * 宽 * 高)
PA 双拼波纹管 	PA-AD14	8.9*13.8	32.00	25	35*35*15
	PA-AD20	12.8*18.7	40.00	25	40*40*16
	PA-AD25	20*25.8	48.00	25	50*50*19
	PA-AD32	24.8*31.4	32.00	25	52*52*19
	PA-AD42	31.4*41.9	64.00	25	70*70*20
	PA-AD54	43.3*54.5	90.00	25	73*73*32

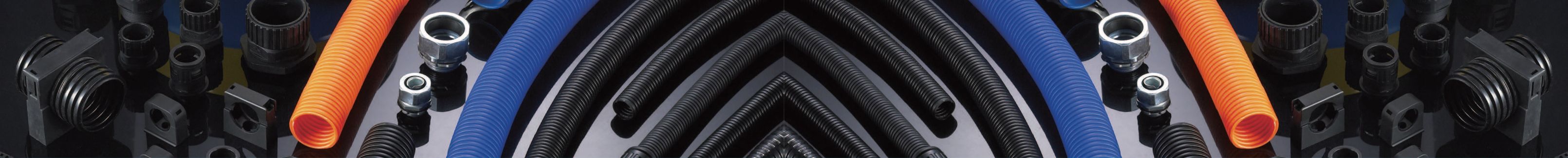

产品名称	规格	单价(元/kg)	规格	单价(元/kg)
PVC 热缩管 	Φ8-Φ75	36.00	Φ130-Φ142	44.00
	Φ80-Φ116	38.00	Φ154-Φ168	60.00

常用色蓝色和黑色，其它色另加1元。

产品名称	规格	单价	规格	单价
Y型橡胶三通接头 	3*10	6.60	3*21.2	13.00
	3*13	6.60	21.2/2*18.5	13.00
	13/2*10	6.60	28.5/2*21.2	23.40
	3*15.8	9.40	34.5/2*28.5	28.60
	15.8/2*13	9.40	42.5/2*34.5	33.80
	3*18.5	11.60	54.5/2*42.5	36.40
	18.5/2*15.8	11.60		

产品名称	规格	单价
T型橡胶三通接头 	3*10	5.20
	3*13	5.20
	3*15.8	7.80
	3*18.5	10.40
	3*21.2	11.60
	3*25	13.00
	3*28.5	21.00
	3*34.5	26.00
	3*42.5	31.60
	3*54.5	35.00

产品名称	规格	单价
直通 	2*10	3.90
	2*13	3.90
	2*15.8	5.20
	2*18.5	7.80
	2*21.2	7.80
	2*25	9.60
	2*28.5	13.00
	2*34.5	15.60
	2*42.5	19.60
	2*54.5	22.60

## 专业配电箱、配电柜、控制箱、PLC编程定制

**成套动力柜 非标定制**  
质保两年·量大从优

可开发票 非标定制 来图报价



可按要求定制

**双电源切换箱 非标定制**  
当天发货·量大从优

厂家直销 2P 快速 63A 转换



可按要求定制

**低压开关柜**  
可开发票·量大从优·快速报价



可按要求定制

成套定制·室外防水·尺寸齐全

**一级柜 二级柜 三级箱** 现货直发



CCC认证 非标订制 厂家直销

**水泵控制箱 正泰开关**  
当天发货·质保两年

短路保护 过载保护 漏电保护



0.75-22KW现货 支持订制

产销一体  
10年生产高性价比产品

权威认证  
3C认证 质检报告

售后无忧  
客服在线快速解决问题

非标定制  
根据客户或技术要求设计



厂家直销



可开增值税发票 增值税普通发票 非标定制 正品保证质保2年

组装定做-成套动力柜

厂家直销



售后无忧·多重防护 运行安全可靠 非标定制 使用寿命长久

GGD-进出线柜开关配电柜

厂家直销



售后无忧·加厚箱体 更加耐磨耐用 非标定制 使用寿命长久

定做-低压抽屉式开关