

本产品手册资料由金角兽印制，仅用于说明本系列产品的相关信息。金角兽随时可能因技术升级或采用更新的生产工艺而改进本手册有关内容，或对本手册印刷错误及不准确的信息进行必要的改进和更改，恕不另行通知。商家订货时请随时联系本公司，以证实有关信息。

本画册采用生态纸印刷。珍惜资源，善待环境。

THIS ALBUM IS PRINTED ON ECOLOGICAL PAPER. CHERISH RESOURCES AND BE KIND TO THE ENVIRONMENT.

气动元件

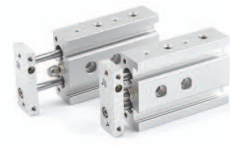

XB2施耐德按钮系列



三色警灯系列



富士型AH164型开关

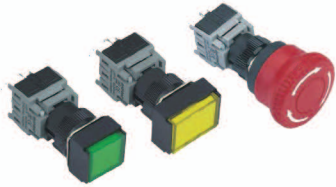

波纹管系列



尼龙拖链系列



“金角兽”机械自动化设备控制系统产品提供商，更多产品详情介绍登入网站

网址：www.goldenhorn.cn



金角兽
JIN JIAO SHOU
4008-270-668

气动 工控 电气

Quality as the root · Service as the base
品质为根 · 服务为本

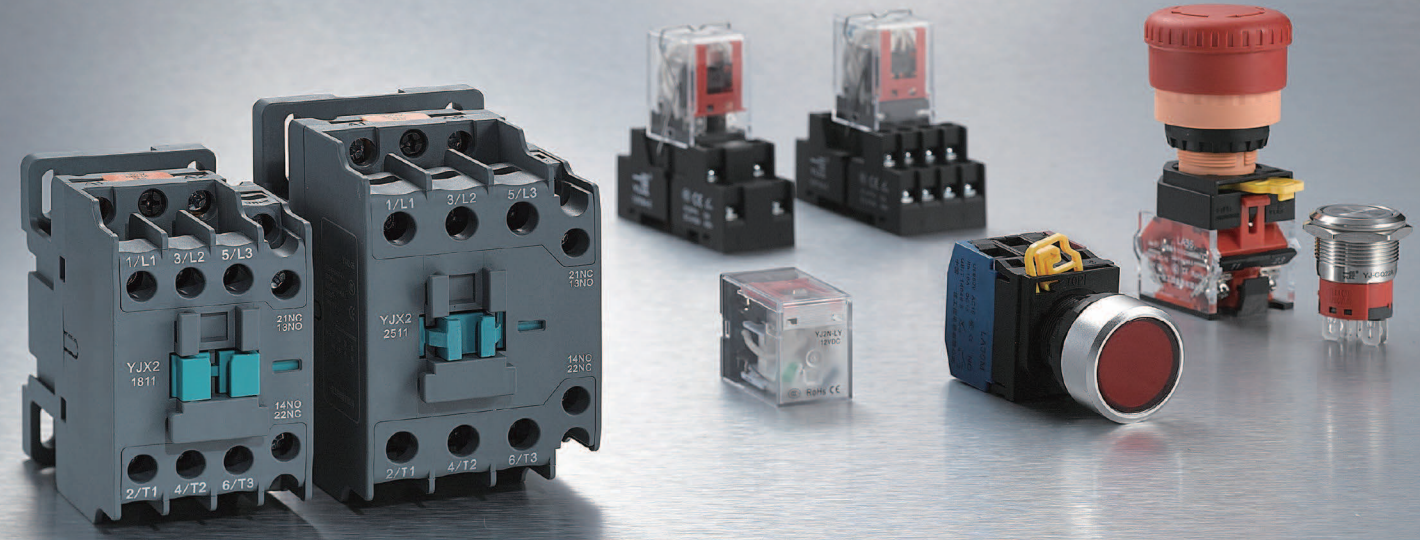

ISO 9001, RoHS, CCC, CE 2021-01 版

专业制造：交流接触器 / 继电器 / 按钮开关 / 信号灯

4008-270-668

手机1: 134-1222-6797

手机2: 186-8005-2736

网址: www.goldenhorn.cn

地址: 广东省东莞市莞城区八达电子城 1 号



扫码进入商城



咨询客服1



咨询客服2

机械自动化设备控制系统产品解决方案提供商

资质证书 & 关于我们 QUALIFICATION CERTIFICATE AND ABOUT US

CERTIFICATE 资质证书



ABOUT US 关于我们

金角兽是集研发、制造、销售为一体的专业气动元件生产企业，专业生产滑台气缸、无杆气缸、旋转气缸、手指气缸、摆动气缸、金属按钮开关、波纹管、尼龙拖链等高端产品。公司本着顾客至上，精益求精的经营理念，不断壮大发展，在不断加强产品的质量管理及信后服务的同时，还非常注重科技人才的培养和科研事业的投入。现已拥有专业的研发的精良队伍。自创办以来，力求产品的不断创新，以品质优良，品种繁多，外形新颖，价格合理，服务完善的特点赢得了广大客户的信任和赞誉。

金角兽凭着认真，负责及积极热情地态度，将会在气动工业领域里，开创一片更为广阔的天地。本公司热忱欢迎您的加盟，一同携手耕耘，共创精彩人生。全国服务热线：4008-270-688

Jinjiaozhen is a professional pneumatic component manufacturer integrating R & D, manufacturing and sales, specializing in the production of high-end products such as slide cylinder, Rodless cylinder, rotary cylinder, finger cylinder, swing cylinder, metal button switch, bellows, nylon drag chain, etc. In line with the business philosophy of customer first and striving for improvement, the company has been constantly expanding and developing. While continuously strengthening the quality management and after-sales service of products, it also attaches great importance to the cultivation of scientific and technological talents and the investment in scientific research. Now we have a professional R & D team. Since its establishment, we have been striving for continuous innovation of our products. We have won the trust and praise of our customers for their excellent quality, wide variety, novel appearance, reasonable price and perfect service.

With a serious, responsible and enthusiastic attitude, golden horn will create a broader world in the field of pneumatic industry. We warmly welcome you to join us and work together to create a wonderful life. National Service Hotline: 4008-270-688

产品目录 Products contents

1		YJX2 系列通用型交流接触器 YJX2 Series Universal AC Contactor Page: 6-7	6		YJ139-LA38A 系列按钮开关 $\Phi 22$ YJ139-LA38A Series Button Switch Page: 24-25	11		AD16 系列信号指示灯 $\Phi 16$ 、 $\Phi 22$ AD16 Series Signal Lamp Page: 34-35	15		YJ-LA12 系列按钮开关 $\Phi 12$ YJ-LA12 Series Button Switch Page: 42-43
2		YJ 系列电磁继电器 YJ Series Electromagnetic Relay Page: 8-9	7		YJ139-LA38M 系列按钮开关 $\Phi 22$ YJ139-LA38M Series Button Switch Page: 26-27	12		YJ139-XB2 系列按钮开关 $\Phi 22$ YJ139-XB2 Series Button Switch Page: 36-37	16		YJ-F16 系列按钮开关 $\Phi 16$ YJ-F16 Series Button Switch Page: 44-45
3		YJ-GQ 系列金属按钮 $\Phi 6$ 、 $\Phi 8$ 、 $\Phi 12$ 、 $\Phi 16$ 、 $\Phi 19$ 、 $\Phi 22$ 、 $\Phi 25$ 、 $\Phi 30$ YJ-GQ Series Metal Button Page: 10-17	8		YJ139-LA38A $\Phi 30$ 系列超薄面按钮开关 $\Phi 30$ YJ139-LA38A $\Phi 30$ Ultrathin Surface Series Button Switch Page: 28-29	13		YJ139-LA39 系列按钮开关 $\Phi 22$ YJ139-LA39 Series Button Switch Page: 38-39	17		Accessories 按钮开关附件 Button switch accessories Page: 46-48
4		LA36 系列按钮开关 $\Phi 22$ LA36 Series Button Switch Page: 18-20	9		YJ-LA16 系列按钮开关 $\Phi 16$ YJ-LA16 Series Button Switch Page: 30-31	14		YJ139-LAY37 系列按钮开关 $\Phi 22$ 、 $\Phi 25$ 、 $\Phi 30$ YJ139-LAY37 Series Button Switch Page: 40-41	18		YJX 系列按钮盒 YJX Series Button Box Page: 49
5		LA36M 系列按钮开关 $\Phi 22$ LA36M Series Button Switch Page: 21-23	10		YJ-LA16W 系列超薄面按钮开关 $\Phi 22$ YJ-LA16W Series Ultrathin Surface Button Switch Page: 32-33						

1 AC contactor

YJX2 系列通用型交流接触器 YJX2 Series Universal AC Contactor

1. 额定工作电压 (Ue) : 380V, 660V
 2. 额定绝缘电压 (Ui) : 690V
 3. 额定工作电流 (Ie) : 9A-95A
 4. 辅助触头:
 额定发热电流 (Ith) : 10A;
 额定工作电压 (Ue) : AC380V, DC220V;
 额定控制容量:
 AC-15: 360VA; DC-13: 33W;
1. Rated working voltage (Ue) : 380V, 660V
 2. Rated insulation voltage (Ui) : 690V
 3. Rated working current (Ie) : 9A-95A
 4. Auxiliary contact:
 Rated heating current (Ith) : 10A;
 Rated working voltage (Ue) : AC380V, DC220V;
 Rated control power:
 AC-15: 360VA; DC-13: 33W;

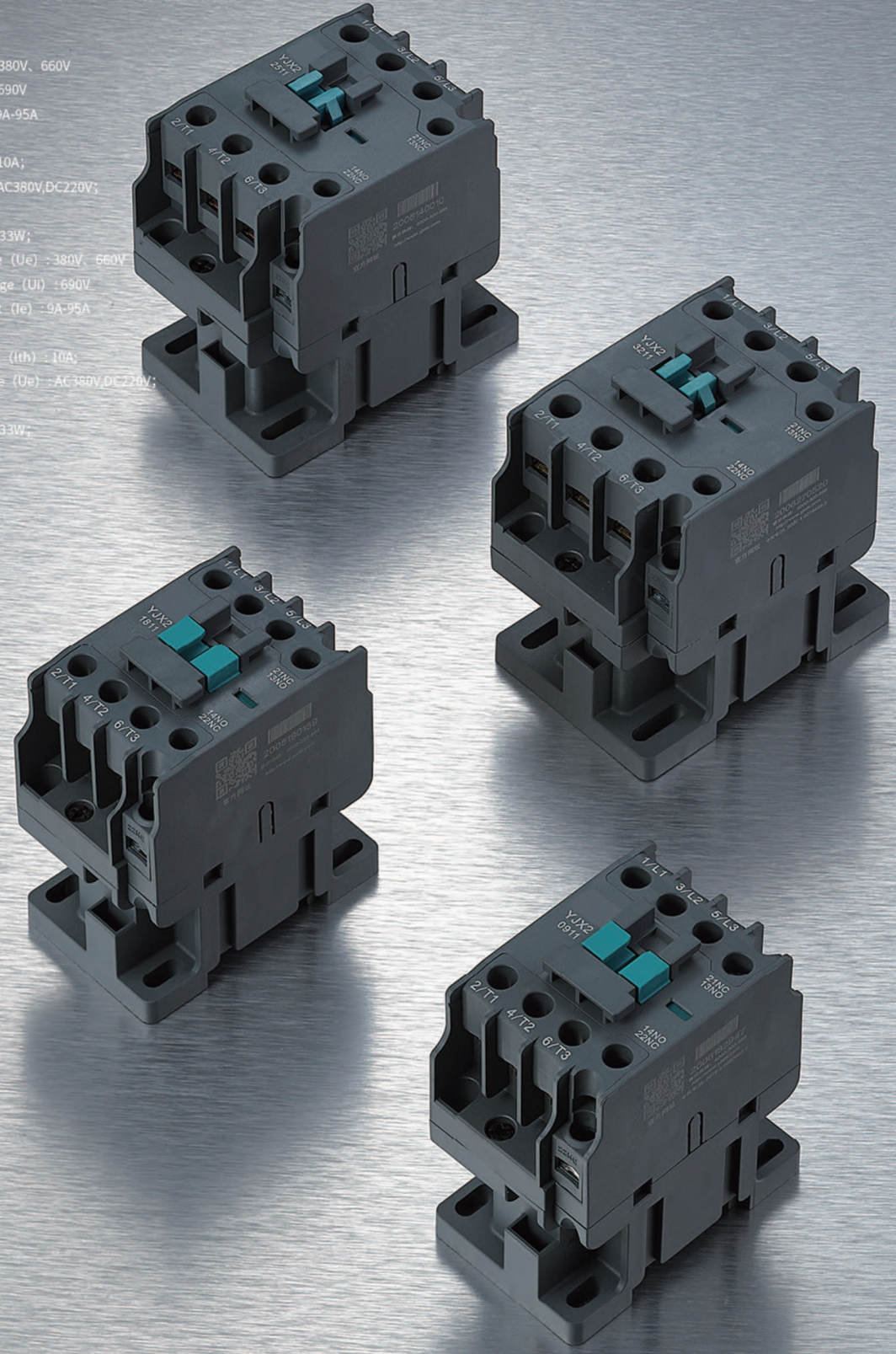









全国服务热线: 4008-270-668

Product price list 产品价格表

AC contactor

YJX2 系列通用型交流接触器 YJX2 Series Universal AC Contactor

△ 线圈电压 Coil voltage	AC24V, AC36V, AC110V, AC220V, AC380V
◇ 工作电流范围 Working current range	0.1-0.6A, 0.16-0.25A, 0.25-0.4A, 0.4-0.63A, 0.63-1A, 1-1.6A, 1.25-2A, 1.6-2.5A, 2.5-4A, 4-6A, 5.5-8A, 7-10A, 9-13A, 12-18A, 17-25A
辅助触头数字代号说明 Digital code for auxiliary contacts	10: 一常开; 01: 一常闭; 11: 一常开+一常闭; 20: 二常开; 02: 二常闭; 22: 二常开+二常闭; 40: 四常开; 04: 四常闭; 31: 三常开+一常闭; 13: 一常开+三常闭; 10: 1NO; 01: 1NC; 11: 1NO1NC; 20: 2NO; 02: 2NC; 22: 2NO2NC; 40: 4NO; 04: 4NC; 31: 3NO1NC; 13: 1NO3NC;

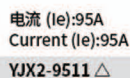
 <p>电流 (Ie):9A Current (Ie):9A 一常开辅助触头: YJX2-0910 △ 一常闭辅助触头: YJX2-0901 △ 一常开一常闭辅助触头: YJX2-0911 △</p>	 <p>电流 (Ie):12A Current (Ie):12A 一常开辅助触头: YJX2-1210 △ 一常闭辅助触头: YJX2-1201 △ 一常开一常闭辅助触头: YJX2-1211 △</p>	 <p>电流 (Ie):18A Current (Ie):18A 一常开辅助触头: YJX2-1810 △ 一常闭辅助触头: YJX2-1801 △ 一常开一常闭辅助触头: YJX2-1811 △</p>
 <p>电流 (Ie):25A Current (Ie):25A 一常开一常闭辅助触头: YJX2-2511 △</p>	 <p>电流 (Ie):32A Current (Ie):32A 一常开一常闭辅助触头: YJX2-3211 △</p>	 <p>电流 (Ie):40A Current (Ie):40A YJX2-4011 △</p>
 <p>电流 (Ie):50A Current (Ie):50A YJX2-5011 △</p>	 <p>电流 (Ie):65A Current (Ie):65A YJX2-6511 △</p>	 <p>电流 (Ie):80A Current (Ie):80A YJX2-8011 △</p>
 <p>电流 (Ie):95A Current (Ie):95A YJX2-9511 △</p>	<p>辅助触头 (2对) Auxiliary contact (2 pairs) 可选型号: F4-11, F4-20, F4-02</p>	<p>辅助触头 (4对) Auxiliary contact (4 pairs) 可选型号: F4-22, F4-40, F4-04, F4-31, F4-13</p>

Relay

YJ 系列电磁继电器 YJ Series Electromagnetic Relay

1. 红色机械指示灯: 可直观判断继电器是否吸合。
 2. LED 动作指示灯: 可识别 AC 或者 DC 线圈规格, 可判断线圈是否通电。
 3. 小功率电磁继电器额定值: AC240V/DC28V, 5A。
 4. 大功率电磁继电器额定值: AC240V/DC28V, 10A。
 5. 机械寿命: 4000 万次;
电气寿命: 2 组 50 万次, 3 组 4 组 20 万次。
- 1.Red mechanical indicator: It can intuitively judge whether the relay is attracted.
- 2.LED signal lamp: It can judge the AC or DC coil, and judge whether the coil is energized.
- 3.Low power electromagnetic relay rated load: AC240V/DC28V, 5A.
- 4.High power electromagnetic relay rated load: AC240V/DC28V, 10A.
- 5.Mechanical life: 40,000,000 times;
Electrical life: 2 pairs is 500,000 times, 3 pairs and 4 pairs is 200,000 times.



金角兽
JIN JIAO SHOU
☎ 4008-270-668



全国服务热线: 4008-270-668

Product price list 产品价格表

Relay

YJ 系列电磁继电器 YJ Series Electromagnetic Relay

△ 线圈电压 交流 (AC): 6VAC、12VAC、24VAC、36VAC、48VAC、110VAC、220VAC、380VAC
Coil voltage 直流 (DC): 5VDC、6VDC、12VDC、24VDC、36VDC、48VDC、110VDC、220VDC



2 组小功率 (8 针)
2 pairs low power (8pin)
YJ2N-GS △



3 组小功率 (11 针)
3 pairs low power (11pin)
YJ3N-GS △



4 组小功率 (14 针)
4 pairs low power (14pin)
YJ4N-GS △



2 组大功率 (8 针)
2 pairs high power (8pin)
YJ2N-LY △

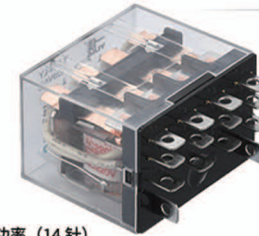

4 组大功率 (14 针)
4 pairs high power (14pin)
YJ4N-LY



2 组小功率底座
2 pairs low power relay socket
YJF08A-E



3 组小功率底座
3 pairs low power relay socket
YJF11B-E



4 组小功率底座
4 pairs low power relay socket
YJF14A-E



2 组大功率底座
2 pairs high power relay socket
YJTF08A-E

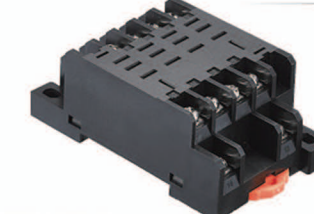

4 组大功率底座
4 pairs high power relay socket
YJTF14A-E

开关部 Switch part

	小功率 2 组 Low power 2 pairs		小功率 3 组 4 组 Low power 3 pairs 4 pairs		大功率 2 组 High power 2 pairs		大功率 4 组 High power 4 pairs	
	阻性负载 Resistive Load	感性负载 Inductive load ($\cos\phi=0.4$, L/R=7ms)	阻性负载 Resistive Load	感性负载 Inductive load ($\cos\phi=0.4$, L/R=7ms)	阻性负载 Resistive Load	感性负载 Inductive load ($\cos\phi=0.4$, L/R=7ms)	阻性负载 Resistive Load	感性负载 Inductive load ($\cos\phi=0.4$, L/R=7ms)
接点构成 Contact form	2c		3c、4c		2c		4c	
接点机构 Contact structure	单接点 Single contact							
接点材质 Contact material	Ag 合金							
额定负载 Rated load	AC220V 5A DC24V 5A	AC220V 2A DC24V 2A	AC220V 3A DC24V 3A	AC220V 0.8A DC24V 1.5A	AC110V 10A DC24V 10A	AC110V 7.5A DC24V 5A	AC110V 10A DC24V 10A	AC110V 7.5A DC24V 5A
额定通电流 Rated current	5A		3A		10A		10A	
接点电压最大值 Max contact voltage	AC250V、DC125V		AC250V、DC125V		AC250V、DC125V		AC250V、DC125V	
接点电流最大值 Max contact current	5A		3A		10A		10A	
开关容量最大值 Max switch capacity	100VA 120W	440VA 48W	660VA 720W	176VA 36W	100VA 240W	440VA 96W	100VA 240W	440VA 96W

Metal Button

YJ-GQ 系列金属按钮
YJ-GQ Series Metal Button

1. 安装孔尺寸: $\Phi 6$ 、 $\Phi 8$ 、 $\Phi 12$ 、 $\Phi 16$ 、 $\Phi 19$ 、 $\Phi 22$ 、 $\Phi 25$ 、 $\Phi 30$ 。
2. 金属壳体可选材质: 黄铜镀铬、不锈钢、铝合金镀色。
3. 带灯类型: 环形灯、电源标志灯、环形带电源标志灯、单点灯。
4. 开关额定值: 250VAC 5A/10A/18A。
5. 机械寿命: ≥ 100 万次。
6. 电气寿命: ≥ 20 万次。
7. 防护等级: IP65/IP67。
1. Installation dimensions:
 $\Phi 6$ 、 $\Phi 8$ 、 $\Phi 12$ 、 $\Phi 16$ 、 $\Phi 19$ 、 $\Phi 22$ 、 $\Phi 25$ 、 $\Phi 30$ 。
2. The shell material: brass clad Chromium, stainless steel, aluminum alloy plating.
3. Lamp type: ring, luminous power logo, luminous power logo and ring, dot.
4. Rated voltage and current: 250VAC 5A/10A/18A.
5. Mechanical life:
 $\geq 1,000,000$ times.
6. Electrical life: $\geq 200,000$ times.
7. IP degree: IP65/IP67.



金角獸
JIN JIAO SHOU
4008-270-668



全国服务热线: 4008-270-668

Product price list 产品价格表

Metal Button

YJ-GQ 系列金属按钮 YJ-GQ Series Metal Button

⊙ 触点结构 Contact	11: 一常开+一常闭; 22: 二常开+二常闭 11: 1NO1NC; 22: 2NO2NC	△ 带灯电压 LED voltage	1.8V、3V、6V、12V、24V、36V、48V、 110V、220V、380V	○ 发光颜色 LED color	R G Y B W
◇ 操作类型 Operation	无字母表示自复 / Z: 自锁 No letter: momentary / Z: maintained	☆ 壳体材料 shell material	N: 黄铜镀铬 / S: 不锈钢 / A: 铝合金镀色 N: Brass clad Chromium / S: Stainless steel / A: Aluminum alloy plating	⊖ 操作位置 Position	21: 二位置保持式 / 31: 三位置保持式 21: Two position maintained / 31: Three position maintained



Φ6 金属信号灯 (带线)
Φ6 metal signal lamp (With line)
GQ6A-D/N △○



Φ8 金属信号灯 (焊接脚)
Φ8 metal signal lamp (pin terminal)
GQ8A-D/J/N △○



Φ10 金属信号灯 (焊接脚)
Φ10 metal signal lamp (pin terminal)
GQ10A-D/J/N △○



Φ12 金属信号灯 (焊接脚)
Φ12 metal signal lamp (pin terminal)
GQ12A-D/J/ ☆△○



Φ16 金属信号灯 (焊接脚)
Φ16 metal signal lamp (pin terminal)
GQ16A-D/J/ ☆△○



Φ19 金属信号灯 (焊接脚)
Φ19 metal signal lamp (pin terminal)
GQ19A-D/J/ ☆△○



Φ22 金属信号灯 (焊接脚)
Φ22 metal signal lamp (pin terminal)
GQ22A-D/J/ ☆△○



Φ25 金属信号灯 (焊接脚)
Φ25 metal signal lamp (pin terminal)
GQ25A-D/J/ ☆△○



Φ12 金属信号灯 (接线柱)
Φ12 metal signal lamp (screw terminal)
GQ12A-D/ ☆△○



Φ16 金属信号灯 (接线柱)
Φ16 metal signal lamp (screw terminal)
GQ16A-D/ ☆△○



Φ19 金属信号灯 (接线柱)
Φ19 metal signal lamp (screw terminal)
GQ19A-D/ ☆△○



Φ22 金属信号灯 (接线柱)
Φ22 metal signal lamp (screw terminal)
GQ22A-D/ ☆△○



Φ25 金属信号灯 (接线柱)
Φ25 metal signal lamp (screw terminal)
GQ25A-D/ ☆△○

Metal Button

YJ-GQ 系列金属按钮 YJ-GQ Series Metal Button

触点结构 Contact	11: 一常开 + 一常闭; 22: 二常开 + 二常闭 11: 1NO1NC; 22: 2NO2NC	带灯电压 LED voltage	1.8V、3V、6V、12V、24V、36V、48V、 110V、220V、380V	发光颜色 LED color	R G Y B W
操作类型 Operation	无字母表示自复 / Z: 自锁 No letter: momentary / Z: maintained	壳体材料 shell material	N: 黄铜镀铬 / S: 不锈钢 / A: 铝合金镀色 N: Brass clad Chromium / S: Stainless steel / A: Aluminum alloy plating	操作位置 Position	21: 二位保持式 / 31: 三位保持式 21: Two position maintained / 31: Three position maintained

<p>可选触点: 10: 1 常开 01: 1 常闭</p>  <p>Φ16/Φ19 平头 (10A 电流) Φ16 / Φ19 Flat (10A current)</p> <p>GQ16AF-10 ◇ / ☆ GQ19AF-10 ◇ / ☆</p>	<p>可选触点: 10: 1 常开 01: 1 常闭</p>  <p>Φ16/Φ19 高头 (10A 电流) Φ16 / Φ19 High (10A current)</p> <p>GQ16AH-10 ◇ / ☆ GQ19AH-10 ◇ / ☆</p>	<p>可选触点: 10: 1 常开 01: 1 常闭</p>  <p>Φ16/Φ19 平头带环形灯 (10A 电流) Φ16 / Φ19 Flat Ring lamp (10A current)</p> <p>GQ16AF-10E ◇ / ☆△○ GQ19AF-10E ◇ / ☆△○</p>
--	--	--

<p>可选触点: 10: 1 常开 01: 1 常闭</p>  <p>Φ16/Φ19 高头带环形灯 (10A 电流) Φ16 / Φ19 High Ring lamp (10A current)</p> <p>GQ16AH-10E ◇ / ☆△○ GQ19AH-10E ◇ / ☆△○</p>	<p>可选触点: 10: 1 常开 01: 1 常闭</p>  <p>Φ16/Φ19 平头环形灯带电源标志 (10A 电流) Φ16 / Φ19 Flat ring lamp with luminous power logo (10A current)</p> <p>GQ16AF-10E ◇ P / ☆△○ GQ19AF-10E ◇ P / ☆△○</p>	 <p>GQ16A 按钮可选配该连接器, 线的数量和长度可定制 GQ16A button can be matched with the socket, the number and length of the wire can be customized.</p> <p>GQ16A 连接器 (4 线) GQ16A Socket with 4 wires</p>
--	---	---

<p>可选触点: 11: 1 常开 1 常闭 (默认) 20: 2 常开 02: 2 常闭 10: 1 常开 01: 1 常闭</p>  <p>Φ22/Φ25 平头 (18A 电流) Φ22 / Φ25 Flat (18A current)</p> <p>GQ22AF-11 ◇ / ☆ GQ25AF-11 ◇ / ☆</p>	<p>可选触点: 11: 1 常开 1 常闭 (默认) 20: 2 常开 02: 2 常闭 10: 1 常开 01: 1 常闭</p>  <p>Φ22/Φ25 高头 (18A 电流) Φ22 / Φ25 High (18A current)</p> <p>GQ22AH-11 ◇ / ☆ GQ25AH-11 ◇ / ☆</p>	<p>可选触点: 11: 1 常开 1 常闭 (默认) 20: 2 常开 02: 2 常闭 10: 1 常开 01: 1 常闭</p>  <p>Φ22/Φ25 平头带环形灯 (18A 电流) Φ22 / Φ25 Flat Ring lamp (18A current)</p> <p>GQ22AF-11E ◇ / ☆△○ GQ25AF-11E ◇ / ☆△○</p>
---	---	---

<p>可选触点: 11: 1 常开 1 常闭 (默认) 20: 2 常开 02: 2 常闭 10: 1 常开 01: 1 常闭</p>  <p>Φ22/Φ25 高头带环形灯 (18A 电流) Φ22 / Φ25 High Ring lamp (18A current)</p> <p>GQ22AH-11E ◇ / ☆△○ GQ25AH-11E ◇ / ☆△○</p>	<p>可选触点: 11: 1 常开 1 常闭 (默认) 20: 2 常开 02: 2 常闭 10: 1 常开 01: 1 常闭</p>  <p>Φ22/Φ25 平头环形灯带电源标志 (18A 电流) Φ22 / Φ25 Flat ring lamp with luminous power logo (18A current)</p> <p>GQ22AF-11E ◇ P / ☆△○ GQ25AF-11E ◇ P / ☆△○</p>	 <p>GQ22A 按钮可选配该连接器, 线的数量和长度可定制 GQ22A button can be matched with the socket, the number and length of the wire can be customized.</p> <p>GQ22A 连接器 (6 线) GQ22A Socket with 6 wires</p>
---	--	---

Metal Button

YJ-GQ 系列金属按钮 YJ-GQ Series Metal Button

触点结构 Contact	11: 一常开 + 一常闭; 22: 二常开 + 二常闭 11: 1NO1NC; 22: 2NO2NC	带灯电压 LED voltage	1.8V、3V、6V、12V、24V、36V、48V、 110V、220V、380V	发光颜色 LED color	R G Y B W
操作类型 Operation	无字母表示自复 / Z: 自锁 No letter: momentary / Z: maintained	壳体材料 shell material	N: 黄铜镀铬 / S: 不锈钢 / A: 铝合金镀色 N: Brass clad Chromium / S: Stainless steel / A: Aluminum alloy plating	操作位置 Position	21: 二位保持式 / 31: 三位保持式 21: Two position maintained / 31: Three position maintained

 <p>Φ12 球面复位 (接线柱) Φ12 Spherical momentary (screw terminal)</p> <p>GQ12B-10 / ☆</p>	 <p>Φ12 平头 Φ12 Flat momentary</p> <p>GQ12BF-10 ◇ / J / ☆</p>	 <p>Φ12 高头 Φ12 High momentary</p> <p>GQ12BH-10 ◇ / J / ☆</p>
--	---	---

 <p>Φ12 平头带环形灯 Φ12 Flat Ring lamp momentary</p> <p>GQ12BF-10E ◇ / J / ☆△○</p>	 <p>Φ12 高头带环形灯 Φ12 High Ring lamp momentary</p> <p>GQ12BH-10E ◇ / J / ☆△○</p>	 <p>Φ12 平头带电源标志灯 Φ12 Flat luminous power logo lamp momentary</p> <p>GQ12BF-10E ◇ P / J / ☆△○</p>
--	--	---

 <p>Φ16 平头复位 (接线柱) Φ16 Flat momentary (screw terminal)</p> <p>GQ16F-10 / ☆</p>	 <p>Φ16 球面复位 (接线柱) Φ16 Spherical momentary (screw terminal)</p> <p>GQ16B-10 / ☆</p>	 <p>Φ16 高头复位 (接线柱) Φ16 High momentary (screw terminal)</p> <p>GQ16H-10 / ☆</p>
---	--	---

 <p>Φ16 平头复位 (焊接脚) Φ16 Flat momentary (pin terminal)</p> <p>GQ16F-10 / J / ☆</p>	 <p>Φ16 球面复位 (焊接脚) Φ16 Spherical momentary (pin terminal)</p> <p>GQ16B-10 / J / ☆</p>	 <p>Φ16 高头复位 (焊接脚) Φ16 High momentary (pin terminal)</p> <p>GQ16H-10 / J / ☆</p>
---	--	---

 <p>Φ16 平头带环形灯复位 Φ16 Flat Ring lamp momentary</p> <p>GQ16BF-10E / J / ☆△○</p>	 <p>Φ16 高头带环形灯复位 Φ16 High Ring lamp momentary</p> <p>GQ16BH-10E / J / ☆△○</p>	 <p>Φ16 平头环形灯带电源标志复位 Φ16 Flat ring lamp with luminous power logo momentary</p> <p>GQ16BF-10EP / J / ☆△○</p>
--	--	--

Metal Button

YJ-GQ 系列金属按钮 YJ-GQ Series Metal Button

触点结构 Contact	11: 一常开+一常闭; 22: 二常开+二常闭 11: 1NO1NC; 22: 2NO2NC	带灯电压 LED voltage	1.8V、3V、6V、12V、24V、36V、48V、 110V、220V、380V	发光颜色 LED color	R G Y B W
操作类型 Operation	无字母表示自复 / Z: 自锁 No letter: momentary / Z: maintained	壳体材料 shell material	N: 黄铜镀铬 / S: 不锈钢 / A: 铝合金镀色 N: Brass clad Chromium / S: Stainless steel / A: Aluminum alloy plating	操作位置 Position	21: 二位保持式 / 31: 三位保持式 21: Two position maintained / 31: Three position maintained

Φ16 平头 Φ16 Flat GQ16BF-11 ◇ / ☆	Φ16 高头 Φ16 High GQ16BH-11 ◇ / ☆	Φ16 平头带环形灯 Φ16 Flat Ring lamp GQ16BF-11E ◇ / ☆△○
Φ16 高头带环形灯 Φ16 High Ring lamp GQ16BH-11E ◇ / ☆△○	Φ16 平头环形灯带电源标志 Φ16 Flat ring lamp with luminous power logo GQ16BF-11E ◇ P / ☆△○	Φ16 平头带电源标志灯 Φ16 Flat luminous power logo lamp GQ16BF-11D ◇ P / ☆△○
GQ16B 连接器 (5线) GQ16B Socket with 5 wires GQ16B 按钮可选配该连接器, 线的数量和长度可定制 GQ16B button can be matched with the socket, the number and length of the wire can be customized.	Φ16 平头 (二开二闭) Φ16 Flat (2NO2NC) GQ16F-22 ◇ / ☆	Φ16 高头 (二开二闭) Φ16 High (2NO2NC) GQ16H-22 ◇ / ☆
Φ16 平头带环形灯 (二开二闭) Φ16 Flat ring lamp (2NO2NC) GQ16F-22E ◇ / ☆△○	Φ16 高头带环形灯 (二开二闭) Φ16 High ring lamp (2NO2NC) GQ16H-22E ◇ / ☆△○	Φ16 平头带单点灯 (二开二闭) Φ16 Flat dot lamp (2NO2NC) GQ16F-22D ◇ / ☆△○
Φ16 高头带单点灯 (二开二闭) Φ16 High dot lamp (2NO2NC) GQ16H-22D ◇ / ☆△○	Φ16 平头带电源标志灯 (二开二闭) Φ16 Flat luminous power logo lamp (2NO2NC) GQ16F-22D ◇ P / ☆△○	

Metal Button

YJ-GQ 系列金属按钮 YJ-GQ Series Metal Button

触点结构 Contact	11: 一常开+一常闭; 22: 二常开+二常闭 11: 1NO1NC; 22: 2NO2NC	带灯电压 LED voltage	1.8V、3V、6V、12V、24V、36V、48V、 110V、220V、380V	发光颜色 LED color	R G Y B W
操作类型 Operation	无字母表示自复 / Z: 自锁 No letter: momentary / Z: maintained	壳体材料 shell material	N: 黄铜镀铬 / S: 不锈钢 / A: 铝合金镀色 N: Brass clad Chromium / S: Stainless steel / A: Aluminum alloy plating	操作位置 Position	21: 二位保持式 / 31: 三位保持式 21: Two position maintained / 31: Three position maintained

Φ19 平头复位 (接线柱) Φ19 Flat momentary (screw terminal) GQ19F-10 / ☆	Φ19 球面复位 (接线柱) Φ19 Spherical momentary (screw terminal) GQ19B-10 / ☆	Φ19 高头复位 (接线柱) Φ19 High momentary (screw terminal) GQ19H-10 / ☆
Φ19 平头复位 (焊接脚) Φ19 Flat momentary (pin terminal) GQ19F-10/J / ☆	Φ19 球面复位 (焊接脚) Φ19 Spherical momentary (pin terminal) GQ19B-10/J / ☆	Φ19 高头复位 (焊接脚) Φ19 High momentary (pin terminal) GQ19H-10/J / ☆
Φ19 平头带环形灯复位 Φ19 Flat Ring lamp momentary GQ19BF-10E/J / ☆△○	Φ19 平头环形灯带电源标志复位 Φ19 Flat ring lamp with luminous power logo momentary GQ19BF-10EP/J / ☆△○	
Φ19 平头 Φ19 Flat GQ19BF-○◇ / ☆	Φ19 高头 Φ19 High GQ19BH-○◇ / ☆	Φ19 平头带环形灯 Φ19 Flat Ring lamp GQ19BF-○E◇ / ☆△○
Φ19 高头带环形灯 Φ19 High Ring lamp GQ19BH-○E◇ / ☆△○	Φ19 平头环形灯带电源标志 Φ19 Flat ring lamp with luminous power logo GQ19BF-○E◇ P / ☆△○	GQ19B 按钮可选配该连接器, 线的数量和长度可定制 GQ19B button can be matched with the socket, the number and length of the wire can be customized.

Metal Button

YJ-GQ 系列金属按钮 YJ-GQ Series Metal Button

触点结构 Contact	11: 一常开+一常闭; 22: 二常开+二常闭 11: 1NO1NC; 22: 2NO2NC	带灯电压 LED voltage	1.8V、3V、6V、12V、24V、36V、48V、 110V、220V、380V	发光颜色 LED color	R G Y B W
操作类型 Operation	无字母表示自复 / Z: 自锁 No letter: momentary / Z: maintained	壳体材料 shell material	N: 黄铜镀铬 / S: 不锈钢 / A: 铝合金镀色 N: Brass clad Chromium / S: Stainless steel / A: Aluminum alloy plating	操作位置 Position	21: 二位置保持式 / 31: 三位置保持式 21: Two position maintained / 31: Three position maintained



Φ19 小头急停钮
Φ19 Small head Emergency button
GQ19-○ZS/☆



Φ19 大头急停钮
Φ19 Big head Emergency button
GQ19-○ZS/A/☆



Φ19 旋钮
Φ19 Selector switch
GQ19-○X/θ/☆



Φ19 带灯旋钮
Φ19 Selector switch with lamp
GQ19-○XD/θ/☆△○



Φ19 钥匙钮
Φ19 key-lock selector switch
GQ19-○Y/θ/☆



GQ19 连接器 (5 线)
GQ19 Socket with 5 wires
GQ19 按钮可选配该连接器, 线的数量和长度可定制
GQ19 button can be matched with the socket, the number and length of the wire can be customized.



Φ22 平头带环形灯复位
Φ22 Flat ring lamp momentary
GQ22BF-10E/J/☆△○



Φ22 平头环形灯带电源标志复位
Φ22 Flat ring lamp with luminous power logo momentary
GQ22BF-10EP/J/☆△○



Φ22 平头
Φ22 Flat
GQ22BF-○◇/☆



Φ22 高头
Φ22 High
GQ22BH-○◇/☆



Φ22 平头带环形灯
Φ22 Flat Ring lamp
GQ22BF-○E◇/☆△○



Φ22 高头带环形灯
Φ22 High Ring lamp
GQ22BH-○E◇/☆△○



Φ22 平头环形灯带电源标志
Φ22 Flat ring lamp with luminous power logo
GQ22BF-○E◇P/☆△○



GQ22B 连接器 (5 线)
GQ22B Socket with 5 wires
GQ22B 按钮可选配该连接器, 线的数量和长度可定制
GQ22B button can be matched with the socket, the number and length of the wire can be customized.



Φ22 急停钮
Φ22 Emergency button
GQ22-○ZS/☆

Metal Button

YJ-GQ 系列金属按钮 YJ-GQ Series Metal Button

触点结构 Contact	11: 一常开+一常闭; 22: 二常开+二常闭 11: 1NO1NC; 22: 2NO2NC	带灯电压 LED voltage	1.8V、3V、6V、12V、24V、36V、48V、 110V、220V、380V	发光颜色 LED color	R G Y B W
操作类型 Operation	无字母表示自复 / Z: 自锁 No letter: momentary / Z: maintained	壳体材料 shell material	N: 黄铜镀铬 / S: 不锈钢 / A: 铝合金镀色 N: Brass clad Chromium / S: Stainless steel / A: Aluminum alloy plating	操作位置 Position	21: 二位置保持式 / 31: 三位置保持式 21: Two position maintained / 31: Three position maintained



Φ22 旋钮
Φ22 Selector switch
GQ22-○X/θ/☆



Φ22 带灯旋钮
Φ22 Selector switch with lamp
GQ22-○XD/θ/☆△○



Φ22 钥匙钮
Φ22 key-lock selector switch
GQ22-○Y/θ/☆



Φ25 平头
Φ25 Flat
GQ25BF-○◇/☆



Φ25 平头带环形灯
Φ25 Flat Ring lamp
GQ25BF-○E◇/☆△○



Φ30 平头
Φ30 Flat
GQ30BF-○◇/☆



Φ30 平头带环形灯
Φ30 Flat Ring lamp
GQ30BF-○E◇/☆△○



Φ30 平头环形灯带电源标志
Φ30 Flat ring lamp with luminous power logo
GQ30BF-○E◇P/☆△○



GQ25B 连接器 (6 线)
GQ25B Socket with 6 wires
GQ25B 和 GQ30B 按钮可选配该连接器, 线的数量和长度可定制
GQ25B and GQ30B button can be matched with the socket, the number and length of the wire can be customized.



Φ30 环形灯带电源标志
Φ30 Flat Ring lamp with luminous power logo
GQ30C-20E◇P/S△○

Button Switch

LA36 系列按钮开关 LA36 Series Button Switch

1. 安装孔尺寸: $\phi 22$ 。
2. 头部材质:
LA36 系列为塑料头部,
LA36A 系列为金属圈头部。
3. 开关额定值: UI:660V, Ith:10A
4. 机械寿命: ≥ 200 万次。
5. 电气寿命: ≥ 50 万次。

1. Installation dimensions: $\phi 22$.
2. The head material:
LA36 series is plastic
head, LA36A series
is metal head.

3. Rated voltage and current:
UI:660V, Ith:10A.
4. Mechanical life:
 $\geq 2,000,000$ times.
5. Electrical life: $\geq 500,000$ times.

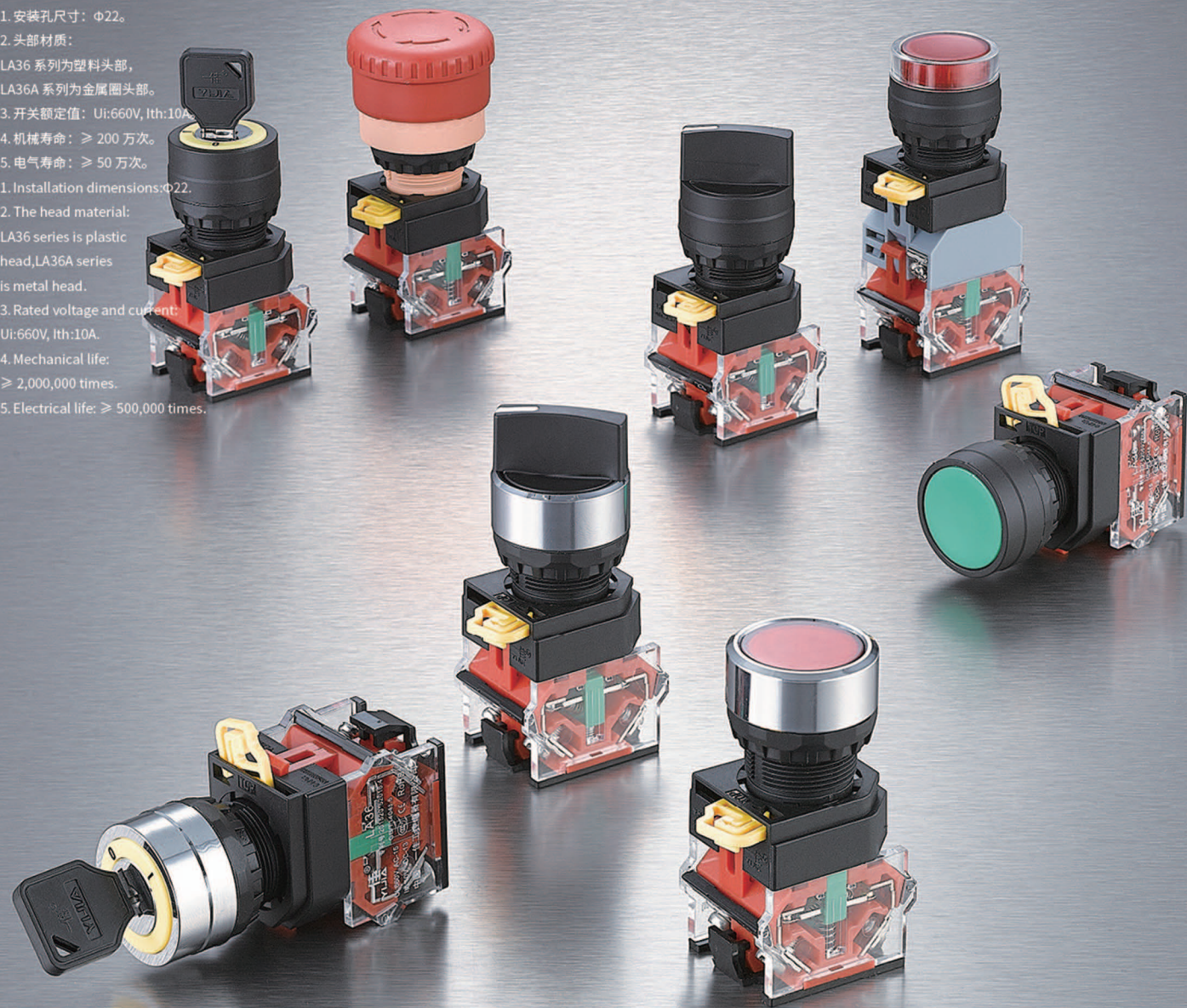

金角獸
JIN JIAO SHOU
4008-270-668



全国服务热线: 4008-270-668

Product price list 产品价格表

Button Switch

LA36 系列按钮开关 LA36 Series Button Switch

触点结构 Contact	11/20/02/10/01/22/40/04/33	带灯电压 LED voltage	(AC/DC) 3V, 6V, 12V, 24V, 36V, 48V, 110V, 220V (AC) 110V, 220V, 380V	颜色 Color	R G Y B W BL
操作类型 Operation	无字母表示自复 / ZS: 自锁 No letter: momentary / ZS: maintained	操作位置 Position	21: 二位置保持式 / 22: 二位置复位式 / 31: 三位置保持式 / 33: 三位置复位式 / 32: 三位置左自锁右复位 21: Two position maintained / 22: Two position momentary / 31: Three position maintained / 33: Three position momentary / 32: Three position left maintained right momentary		



平钮
Flat push button

LA36- \odot BN \diamond / \odot



高钮
High push button

LA36- \odot GN \diamond / \odot



超薄型平钮
Ultrathin flat push button

LA36- \odot BN \diamond / P / \odot



超薄型定制符号平钮
Ultrathin flat Custom symbol push button

LA36- \odot BN \diamond / P / FH (可定制各种符号)



不锈钢头按钮
Stainless steel head push button

LA36- \odot BN \diamond / S



带灯平钮
Illuminated push button

LA36- \odot DN \diamond / Δ \odot

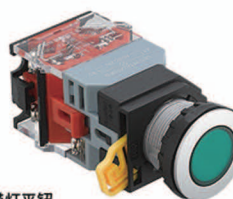

超薄型带灯平钮
Ultrathin flat illuminated push button

LA36- \odot DN \diamond / P / Δ \odot

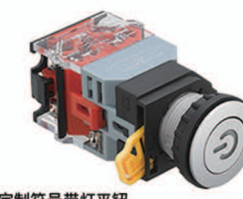

超薄型定制符号带灯平钮
Ultrathin flat illuminated Custom symbol push button

LA36- \odot DN \diamond / P / FH / Δ \odot



不锈钢头环形带灯按钮
Stainless steel head illuminated ring push button

LA36- \odot E \diamond / S / Δ \odot



不锈钢头环形带电源标志灯
Stainless steel head ring lamp with luminous power logo illuminated push button

LA36- \odot E \diamond P / S / Δ \odot



蘑菇头按钮
Mushroom push button

LA36- \odot M \diamond / \odot



蘑菇头带灯按钮
Mushroom illuminated push button

LA36- \odot M \diamond D / Δ \odot



旋钮
Selector switch

LA36- \odot X / θ / \odot



长柄旋钮
Long handle selector switch

LA36- \odot XB / θ / \odot



带灯旋钮
Illuminated selector switch

LA36- \odot XD / θ / Δ \odot

Button Switch

LA36 系列按钮开关 LA36 Series Button Switch

触点结构 Contact	11/20/02/10/01/22/40/04/33	带灯电压 LED voltage	(AC/DC) 3V, 6V, 12V, 24V, 36V, 48V, 110V, 220V (AC) 110V, 220V, 380V	颜色 Color	R G Y B W BL
操作类型 Operation	无字母表示自复 / ZS: 自锁 No letter: momentary / ZS: maintained	操作位置 Position	21: 二位置保持式 / 22: 二位置复位式 / 31: 三位置保持式 / 33: 三位置复位式 21: Two position maintained / 22: Two position momentary / 31: Three position maintained / 33: Three position momentary		

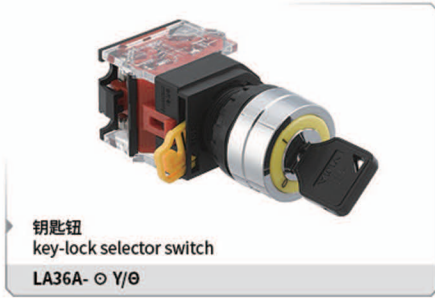
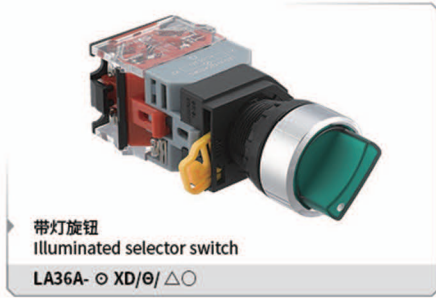
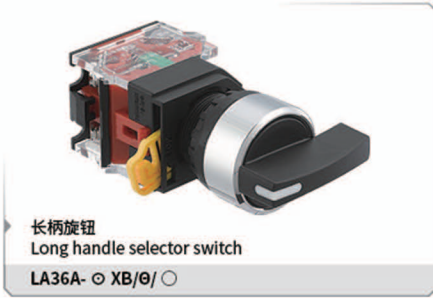
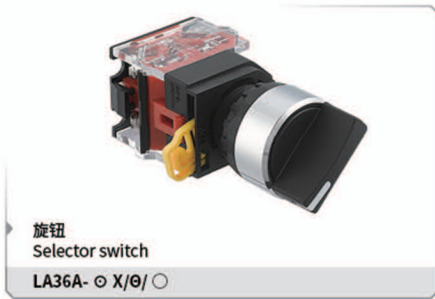
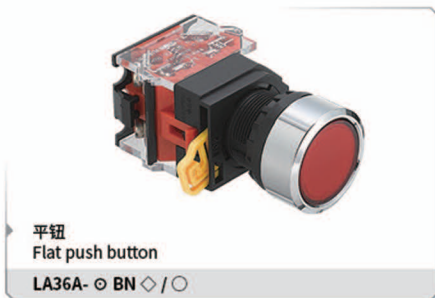
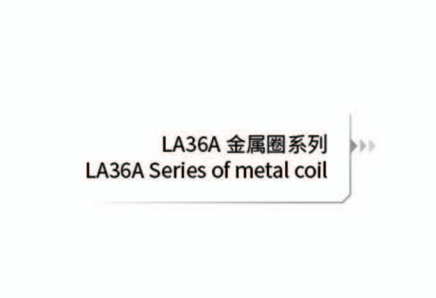
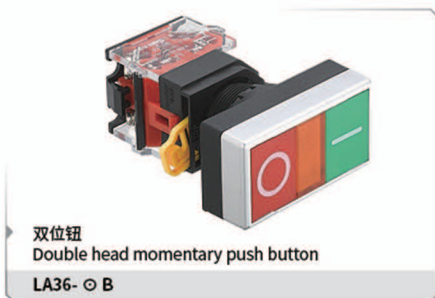

5 Button Switch

LA36M 系列按钮开关 LA36M Series Button Switch

1. 安装孔尺寸: Φ22.
2. 头部材质: LA36 系列为塑料头部, LA36A 系列为金属头部.
3. 开关额定值: U_i:660V, I_{th}:10A.
4. 机械寿命: ≥ 100 万次.
5. 电气寿命: ≥ 50 万次.

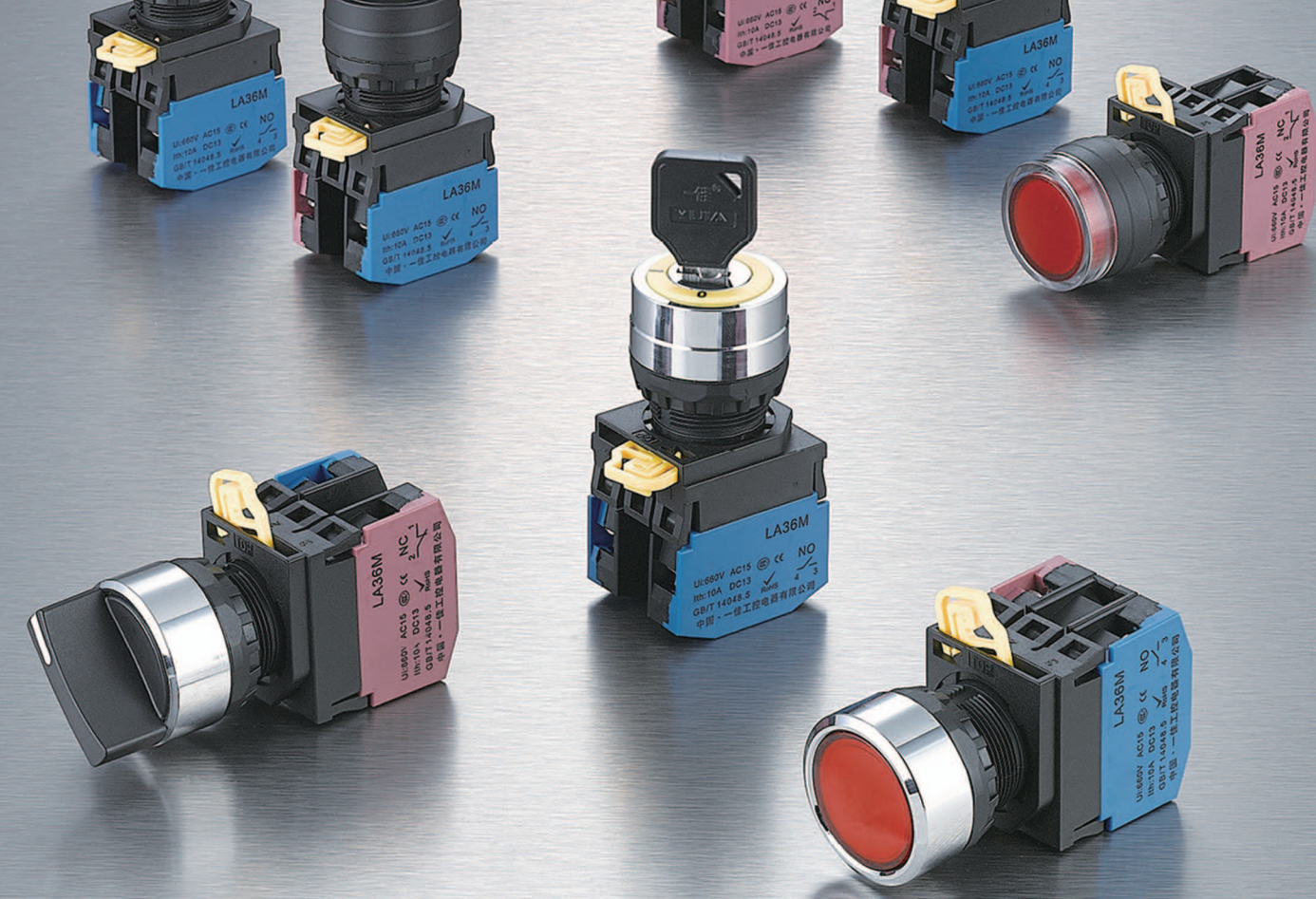

Button Switch

LA36M 系列按钮开关 LA36M Series Button Switch

触点结构 Contact	10/01/11/20/02	带灯电压 LED voltage	(AC/DC) 3V, 6V, 12V, 24V, 36V, 48V, 110V, 220V (AC) 110V, 220V, 380V	颜色 Color	R G Y B W BL
操作类型 Operation	无字母表示自复 / ZS: 自锁 No letter: momentary / ZS: maintained	操作位置 Position	21: 二位置保持式 / 22: 二位置复位式 / 31: 三位置保持式 / 32: 三位置复位式 / 33: 三位置左自锁右复位 21: Two position maintained / 22: Two position momentary / 31: Three position maintained / 32: Three position left maintained right momentary / 33: Three position momentary / 32: Three position left maintained right momentary		

 平钮 Flat push button LA36M-○BN◇/○	 高钮 High push button LA36M-○GN◇/○	 超薄型平钮 Ultrathin flat push button LA36M-○BN◇/P/○
 超薄型定制符号平钮 Ultrathin flat Custom symbol push button LA36M-○BN◇/P/FH(可定制各种符号)	 带灯平钮 Illuminated push button LA36M-○DN◇/△○	 超薄型带灯平钮 Ultrathin flat illuminated push button LA36M-○DN◇/P/△○
 超薄型定制符号带灯平钮 Ultrathin flat Illuminated Custom symbol push button LA36M-○DN◇/P/FH/△○	 蘑菇头按钮 Mushroom push button LA36M-○M◇/○	 蘑菇头带灯按钮 Mushroom illuminated push button LA36M-○M◇/D/△○
 旋钮 Selector switch LA36M-○X/θ/○	 长柄旋钮 Long handle selector switch LA36M-○XB/θ/○	 带灯旋钮 Illuminated selector switch LA36M-○XD/θ/△○
 急停钮 Emergency push button LA36M-○ZS	 钥匙钮 key-lock selector switch LA36M-○Y/θ	

Button Switch

LA36M 系列按钮开关 LA36M Series Button Switch

触点结构 Contact	10/01/11/20/02	带灯电压 LED voltage	(AC/DC) 3V, 6V, 12V, 24V, 36V, 48V, 110V, 220V (AC) 110V, 220V, 380V	颜色 Color	R G Y B W BL
操作类型 Operation	无字母表示自复 / ZS: 自锁 No letter: momentary / ZS: maintained	操作位置 Position	21: 二位置保持式 / 22: 二位置复位式 / 31: 三位置保持式 / 32: 三位置复位式 / 33: 三位置左自锁右复位 21: Two position maintained / 22: Two position momentary / 31: Three position maintained / 32: Three position left maintained right momentary / 33: Three position momentary / 32: Three position left maintained right momentary		

LA36MA 金属圈系列 LA36MA Series of metal coil			 平钮 Flat push button LA36MA-○BN◇/○
 带灯平钮 Flat illuminated push button LA36MA-○DN◇/△○	 高钮 High push button LA36MA-○GN◇/○	 带灯高钮 High illuminated push button LA36MA-○GDN◇/△○	
 定制符号平钮 Flat custom symbol push button LA36MA-○BN◇/FH(可定制各种符号)	 蘑菇头按钮 Mushroom push button LA36MA-○M◇/○	 蘑菇头带灯按钮 Mushroom illuminated push button LA36MA-○M◇/D/△○	
 旋钮 Selector switch LA36MA-○X/θ/○	 长柄旋钮 Long handle selector switch LA36MA-○XB/θ/○	 金属急停钮 Metal emergency button LA36MA-○ZS/A	
 带灯旋钮 Illuminated selector switch LA36MA-○XD/θ/△○	 钥匙钮 key-lock selector switch LA36MA-○Y/θ		



Button Switch

YJ139-LA38A 系列按钮开关
YJ139-LA38A Series Button Switch

- 1. 安装孔尺寸: $\phi 22$.
- 2. 开关额定值: UI:440V, Ith:10A.
- 3. 机械寿命: ≥ 200 万次.
- 4. 电气寿命: ≥ 50 万次.
- 1. Installation dimensions: $\phi 22$.
- 2. Rated voltage and current: UI:440V, Ith:10A.
- 3. Mechanical life: $\geq 2,000,000$ times.
- 4. Electrical life: $\geq 500,000$ times.

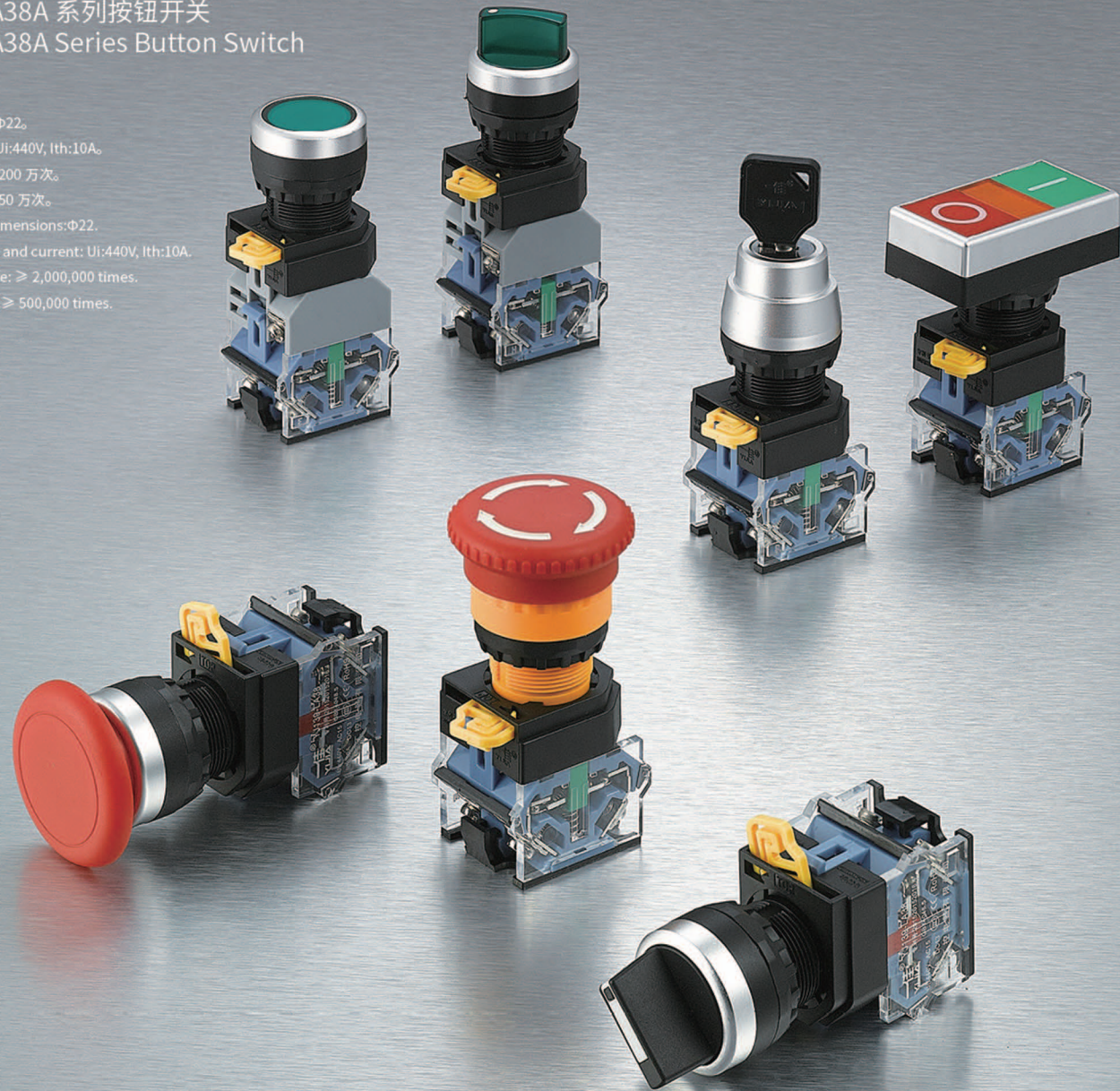

平钮
Flat push button
LA38A- ϕ BN \diamond / \circ

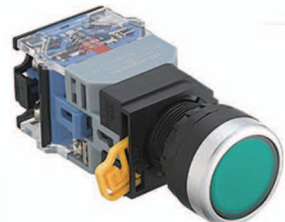

带灯平钮
Flat illuminated push button
LA38A- ϕ DN \diamond / Δ \circ



定制符号平钮
Flat custom symbol push button
LA38A- ϕ BN \diamond / FH (可定制各种符号)



不锈钢头按钮
Stainless steel head push button
LA38A- ϕ BN \diamond / JS

Button Switch

YJ139-LA38A 系列按钮开关 YJ139-LA38A Series Button Switch

触点结构 Contact	11/20/02/10/01/22/40/04/33	带灯电压 LED voltage	(AC/DC) 3V, 6V, 12V, 24V, 36V, 48V, 110V, 220V (AC) 110V, 220V, 380V	颜色 Color	R G Y B W BL
操作类型 Operation	无字母表示自复 / ZS: 自锁 No letter: momentary / ZS: maintained	操作位置 Position	21: 二位置保持式 / 22: 二位置复位式 / 31: 三位置保持式 / 33: 三位置复位式 / 32: 三位置左自锁右复位 21: Two position maintained / 22: Two position momentary / 31: Three position maintained / 33: Three position momentary / 32: Three position left maintained right momentary		



不锈钢头环形带灯钮
Stainless steel head illuminated ring push button
LA38A- ϕ E \diamond JS / Δ \circ



高钮
High push button
LA38A- ϕ GN \diamond / \circ



带灯高钮
High illuminated push button
LA38A- ϕ GDN \diamond / Δ \circ



旋钮
Selector switch
LA38A- ϕ X θ / \circ

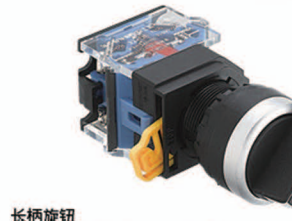

长柄旋钮
Long handle selector switch
LA38A- ϕ XB θ / \circ

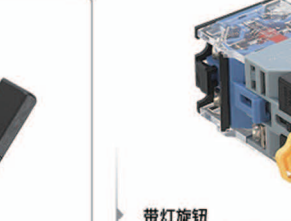

带灯旋钮
Illuminated selector switch
LA38A- ϕ XD θ / Δ \circ



蘑菇头按钮
Mushroom push button
LA38A- ϕ M \diamond / \circ



$\phi 60$ 大蘑菇头按钮
 $\phi 60$ big mushroom push button
LA38A- ϕ M \diamond / 60 \circ

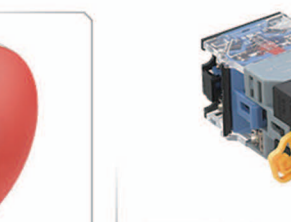

蘑菇头带灯按钮
Mushroom illuminated push button
LA38A- ϕ M \diamond D / Δ \circ



急停钮
Emergency push button
LA38A- ϕ ZS



金属急停钮
Metal emergency button
LA38A- ϕ ZS/A



带 STOP 符号急停钮
STOP symbol Emergency push button
LA38A- ϕ ZS/STOP



$\phi 60$ 大头急停钮
 $\phi 60$ big head Emergency push button
LA38A- ϕ ZS/60



钥匙钮
Key-lock selector switch
LA38A- ϕ Y θ



双位钮
Double head momentary push button
LA38A- ϕ B



双位带灯钮
Double head illuminated momentary push button
LA38A- ϕ D / Δ



金角獸
JIN JIAO SHOU
☎ 4008-270-668



全国服务热线：4008-270-668

Product price list 产品价格表

7

Button Switch

YJ139-LA38M 系列按钮开关
YJ139-LA38M Series Button Switch



















- 1. 安装孔尺寸: $\Phi 22$.
- 2. 开关额定值: $U_i: 440V, I_{th}: 10A$.
- 3. 机械寿命: ≥ 200 万次.
- 4. 电气寿命: ≥ 50 万次.
- 1. Installation dimensions: $\Phi 22$.
- 2. Rated voltage and current: $U_i: 440V, I_{th}: 10A$.
- 3. Mechanical life: $\geq 2,000,000$ times.
- 4. Electrical life: $\geq 500,000$ times.



Button Switch

YJ139-LA38M 系列按钮开关 YJ139-LA38M Series Button Switch

⊙ 触点结构 Contact	10/01/11/20/02	△ 带灯电压 LED voltage	(AC/DC) 3V, 6V, 12V, 24V, 36V, 48V, 110V, 220V (AC) 110V, 220V, 380V	○ 颜色 Color	R G Y B W BL
◇ 操作类型 Operation	无字母表示自复 / ZS: 自锁 No letter: momentary / ZS: maintained	⊖ 操作位置 Position	21: 二位置保持式 / 22: 二位置复位式 / 31: 三位置保持式 / 33: 三位置复位式 / 32: 三位置左自锁右复位 21: Two position maintained / 22: Two position momentary / 31: Three position maintained / 33: Three position momentary / 32: Three position left maintained right momentary		

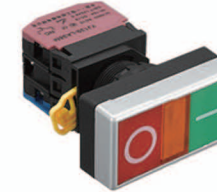
 平钮 Flat push button LA38M-⊙ BN ◇ / ○	 带灯平钮 Flat illuminated push button LA38M-⊙ DN ◇ / △	 高钮 High push button LA38M-⊙ GN ◇ / ○	 带灯高钮 High illuminated push button LA38M-⊙ GDN ◇ / △
 不锈钢头按钮 Stainless steel head push button LA38M-⊙ BN ◇ / S	 不锈钢头环形带灯钮 Stainless steel head illuminated ring push button LA38M-⊙ E ◇ / S / △	 不锈钢头环形带电源标志灯 Stainless steel head ring lamp with luminous power logo illuminated push button LA38M-⊙ E ◇ P / S / △	 定制符号平钮 Flat custom symbol push button LA38M-⊙ BN ◇ / FH (可定制各种符号)
 旋钮 Selector switch LA38M-⊙ X / ⓪	 长柄旋钮 Long handle selector switch LA38M-⊙ XB / ⓪	 带灯旋钮 Illuminated selector switch LA38M-⊙ XD / ⓪	 蘑菇头按钮 Mushroom push button LA38M-⊙ M ◇ / ○
 Φ60 大蘑菇头按钮 Φ60 big mushroom push button LA38M-⊙ M ◇ / 60	 蘑菇头带灯按钮 Mushroom illuminated push button LA38M-⊙ M ◇ D / △	 急停钮 Emergency push button LA38M-⊙ ZS	 带 STOP 符号急停钮 STOP symbol Emergency push button LA38M-⊙ ZS / STOP
 Φ60 大头急停钮 Φ60 big head Emergency push button LA38M-⊙ ZS / 60	 钥匙钮 key-lock selector switch LA38M-⊙ Y / ⓪	 双位钮 Double head momentary push button LA38M-⊙ B	 双位带灯钮 Double head illuminated momentary push button LA38M-⊙ D / △



金角獸
JIN JIAO SHOU
4008-270-668



全国服务热线：4008-270-668

Product price list 产品价格表

8 Button Switch

YJ139-LA38A Φ30 系列超薄面按钮开关
YJ139-LA38A Φ30
Ultrathin Surface Series Button Switch

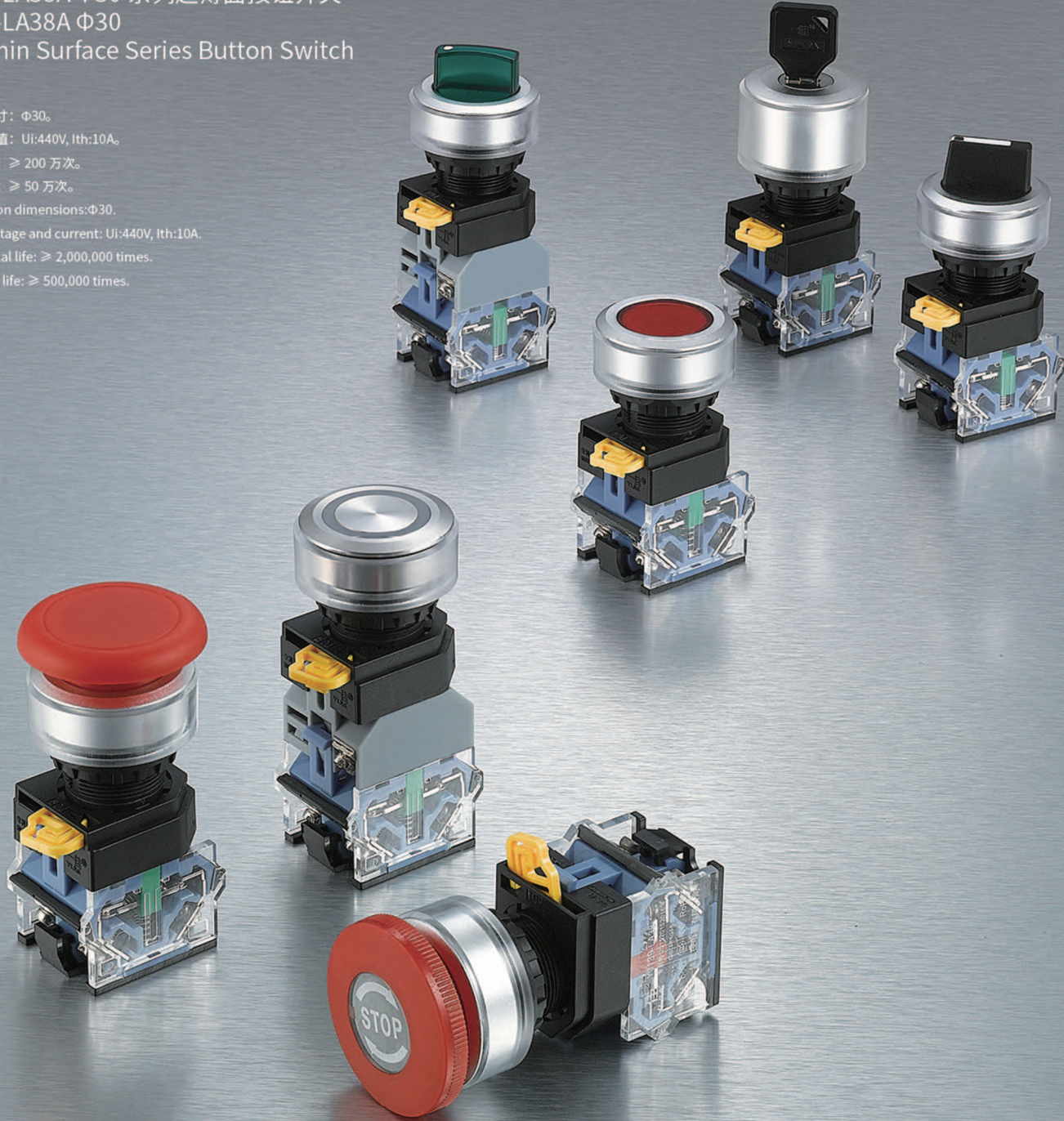

- 1. 安装孔尺寸: Φ30.
- 2. 开关额定值: UI:440V, Ith:10A.
- 3. 机械寿命: ≥ 200 万次.
- 4. 电气寿命: ≥ 50 万次.
- 1. Installation dimensions: Φ30.
- 2. Rated voltage and current: UI:440V, Ith:10A.
- 3. Mechanical life: ≥ 2,000,000 times.
- 4. Electrical life: ≥ 500,000 times.



Button Switch

YJ139-LA38A Φ30 系列超薄面按钮开关 YJ139-LA38A Φ30 Ultrathin Surface

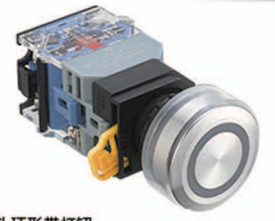
触点结构 Contact	11/20/02/10/01/22/40/04/33	带灯电压 LED voltage	(AC/DC) 3V, 6V, 12V, 24V, 36V, 48V, 110V, 220V (AC) 110V, 220V, 380V	颜色 Color	R G Y B W BL
操作类型 Operation	无字母表示自复 / ZS: 自锁 No letter: momentary / ZS: maintained	操作位置 Position	21: 二位置保持式 / 22: 二位置复位式 / 31: 三位置保持式 / 33: 三位置复位式 / 32: 三位置左自锁右复位 21: Two position maintained / 22: Two position momentary / 31: Three position maintained / 33: Three position momentary / 32: Three position left maintained right momentary		

 <p>平钮 Flat push button Φ30 LA38A-Φ BN ◇ / ○</p>	 <p>带灯平钮 Flat illuminated push button Φ30 LA38A-Φ DN ◇ / △○</p>	 <p>不锈钢头按钮 Stainless steel head push button Φ30 LA38A-Φ BN ◇ / S</p>
 <p>不锈钢头环形带灯钮 Stainless steel head illuminated ring push button Φ30 LA38A-Φ E ◇ / S / △○</p>	 <p>高钮 High push button Φ30 LA38A-Φ GN ◇ / ○</p>	 <p>带灯高钮 High illuminated push button Φ30 LA38A-Φ GDN ◇ / △○</p>
 <p>蘑菇头按钮 Mushroom push button Φ30 LA38A-Φ M ◇ / ○</p>	 <p>蘑菇头带灯按钮 Mushroom illuminated push button Φ30 LA38A-Φ M ◇ D / △○</p>	 <p>带 STOP 符号急停按钮 STOP symbol Emergency push button Φ30 LA38A-Φ ZS/STOP</p>
 <p>旋钮 Selector switch Φ30 LA38A-Φ X / θ / ○</p>	 <p>长柄旋钮 Long handle selector switch Φ30 LA38A-Φ XB / θ / ○</p>	 <p>带灯旋钮 Illuminated selector switch Φ30 LA38A-Φ XD / θ / △○</p>
 <p>钥匙钮 key-lock selector switch Φ30 LA38A-Φ Y / θ</p>		

Button Switch

YJ-LA16 系列按钮开关
YJ-LA16 Series Button Switch

1. 安装孔尺寸: $\Phi 16$.
2. 头部形状: 圆形、正方形、长方形。
3. 开关额定值: UI:250VAC, Ith:5A.
4. 机械寿命: ≥ 100 万次。
5. 电气寿命: ≥ 50 万次。

1. Installation dimensions: $\Phi 16$.
2. The shape of head: round, square, rectangle.
3. Rated voltage and current: UI:250VAC, Ith:5A.
4. Mechanical life: $\geq 1,000,000$ times.
5. Electrical life: $\geq 500,000$ times.



金角獸
JIN JIAO SHOU
4008-270-668



圆形信号灯
round signal lamp
LA16-D/Y $\Delta \circ$



方形信号灯
square signal lamp
LA16-D/F $\Delta \circ$



矩形信号灯
rectangle signal lamp
LA16-D/J $\Delta \circ$



圆形曲面按钮
round curved push button
无灯 (NO LAMP): LA16A- \circ BN \diamond Y \circ
带灯 (WITH LAMP): LA16A- \circ DN \diamond Y $\Delta \circ$

Button Switch

YJ-LA16 系列按钮开关 YJ-LA16 Series Button Switch

触点结构 Contact	11: 一常开 + 一常闭; 22: 二常开 + 二常闭 11: 1NO1NC; 22: 2NO2NC	带灯电压 LED voltage	1.8V、3V、6V、12V、24V、36V、48V、 110V、220V、380V	颜色 Color	R G Y B W BL
操作类型 Operation	无字母表示自复 / ZS: 自锁 No letter: momentary / ZS: maintained	操作位置 Position	21: 二位置保持式 / 31: 三位置保持式 21: Two position maintained / 31: Three position maintained		



圆形按钮
round push button

无灯 (NO LAMP): LA16- \circ BN \diamond Y \circ
带灯 (WITH LAMP): LA16- \circ DN \diamond Y $\Delta \circ$



方形按钮
square push button

无灯 (NO LAMP): LA16- \square BN \diamond F \circ
带灯 (WITH LAMP): LA16- \square DN \diamond F $\Delta \circ$



矩形按钮
rectangle push button

无灯 (NO LAMP): LA16- \square BN \diamond J \circ
带灯 (WITH LAMP): LA16- \square DN \diamond J $\Delta \circ$



蘑菇头按钮
Mushroom push button

无灯 (NO LAMP): LA16- \circ M \diamond \circ
带灯 (WITH LAMP): LA16- \circ M \diamond D $\Delta \circ$



急停按钮
Emergency push button

LA16- \circ ZS



大头急停按钮
Big head emergency push button

LA16- \circ ZS/A



B 型短款急停按钮
B type short emergency button

LA16-02ZS/B



C 型短款急停按钮
C type short emergency button

LA16-02ZS/C



圆形旋钮
round selector switch

LA16- \circ X/ θ /Y \circ

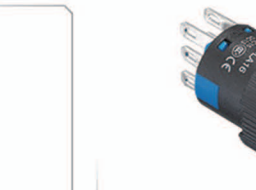

方形旋钮
square selector switch

LA16- \square X/ θ /F \circ



矩形旋钮
rectangle selector switch

LA16- \square X/ θ /J \circ



圆形带灯旋钮
round illuminated selector switch

LA16- \circ XD/ θ /Y \circ



方形带灯旋钮
square illuminated selector switch

LA16- \square XD/ θ /F \circ



矩形带灯旋钮
rectangle illuminated selector switch

LA16- \square XD/ θ /J \circ



圆形钥匙钮
round key-lock selector switch

LA16- \circ Y/ θ /Y



方形钥匙钮
square key-lock selector switch

LA16- \square Y/ θ /F



矩形钥匙钮
rectangle key-lock selector switch

LA16- \square Y/ θ /J



金角獸
JIN JIAO SHOU
☎ 4008-270-668



全国服务热线：4008-270-668

Product price list 产品价格表

Button Switch

YJ-LA16W 系列超薄面按钮开关 YJ-LA16W Series Ultrathin Surface Button Switch

触点结构 Contact	11: 一常开 + 一常闭; 22: 二常开 + 二常闭 11: 1NO1NC; 22: 2NO2NC
操作类型 Operation	无字母表示自复 / ZS: 自锁 No letter: momentary / ZS: maintained

带灯电压 LED voltage	1.8V、3V、6V、12V、24V、36V、48V、 110V、220V、380V
---------------------	---

颜色 Color	R G Y B W BL
-------------	--------------

10 Button Switch

YJ-LA16W 系列超薄面按钮开关
YJ-LA16W Series Ultrathin Surface Button Switch

1. 安装孔尺寸: $\phi 22$ 。
2. 开关额定值: Ui:250VAC, Ith:5A。
3. 机械寿命: ≥ 100 万次。
4. 电气寿命: ≥ 50 万次。
1. Installation dimensions: $\phi 22$.
2. Rated voltage and current: Ui:250VAC, Ith:5A.
3. Mechanical life: $\geq 1,000,000$ times.
4. Electrical life: $\geq 500,000$ times.



 信号灯 signal lamp LA16W-D/Y Δ \circ	 电源符号信号灯 luminous power logo signal lamp LA16W-P/Y Δ \circ	 可定制符号信号灯 Custom symbol signal lamp LA16W-D/Y/FH Δ \circ
 平钮 push button LA16W- \circ BN \diamond /Y \circ	 电源符号平钮 luminous power logo push button LA16W- \circ \diamond P/Y	 可定制符号平钮 Custom symbol push button LA16W- \circ BN \diamond /Y/FH
 带灯平钮 illuminated push button LA16W- \circ DN \diamond /Y Δ \circ	 电源符号带灯平钮 luminous power logo illuminated push button LA16W- \circ D \diamond P/Y Δ \circ	 可定制符号带灯平钮 Custom symbol illuminated push button LA16W- \circ DN \diamond /Y/FH Δ \circ

尺寸: Dimension

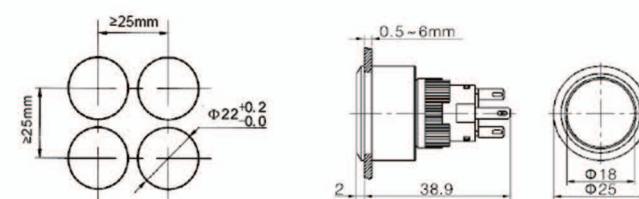

底视图: Bottom view

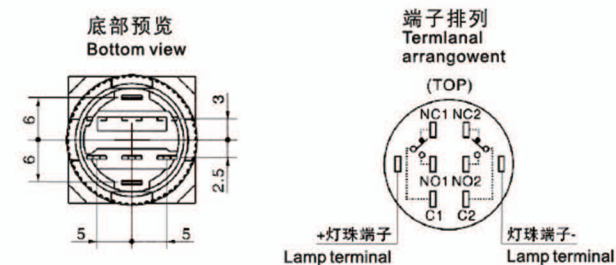



11 Signal Lamp

AD16 系列信号指示灯 AD16 Series Signal Lamp

1. 安装孔尺寸: $\Phi 16$ 、 $\Phi 22$ 。
 2. 工作寿命: ≥ 40000 小时。
 3. 使用频率: 50~60Hz。
 4. 额定工作电流: $\leq 20\text{mA}$ 。
 5. 光亮度: $\geq 100\text{cd/m}^2$ 。
 6. 相比漏电起痕指数 CT1, 阻燃。
 7. 发光颜色: 红、绿、黄、蓝、白。
1. Installation dimensions: $\Phi 16$ 、 $\Phi 22$ 。
 2. Work life: $\geq 40,000$ hours.
 3. Frequency: 50~60Hz.
 4. Rated current: $\leq 20\text{mA}$.
 5. Brightness: $\geq 100\text{cd/m}^2$.
 6. Comparative Tracking Index CT1, flame retardant.
 7. Light color: red, green, yellow, blue, white.



Signal Lamp

AD16 系列信号指示灯 AD16 Series Signal Lamp

△ 工作电压 Voltage (AC/DC) 6V, 12V, 24V, 36V, 48V, 110V, 220V, 380V (AC) 110V, 220V, 380V

○ 颜色 Color R G Y B W BL



☆ 干扰电压伏数 Interference voltage 需要注明具体电压值 Specific voltage values need to be specified.

 <p>Φ16 信号灯 Φ16 Signal lamp AD16-16E △○</p>	 <p>Φ16 抗干扰信号灯 Φ16 Anti-interference signal lamp AD16-16E/K △○抗☆</p>	 <p>Φ16 蜂鸣器 Φ16 Buzzer 蜂鸣器: AD16-16M △○ 闪光蜂鸣器: AD16-16SM △○</p>	 <p>Φ16 红绿双色灯 Φ16 Red and green double-color signal lamp AD16-16SS △</p>
 <p>Φ22 信号灯 Φ22 Signal lamp AD16-22DS △○</p>	 <p>Φ22 抗干扰信号灯 Φ22 Anti-interference signal lamp AD16-22DS/K △○抗☆</p>	 <p>Φ22 放电信号灯 Φ22 Leak electric signal lamp AD16-22DS/F △○</p>	
 <p>Φ22 闪光灯 Φ22 Flicker signal lamp AD16-22S △○</p>	 <p>Φ22 蜂鸣器 Φ22 Buzzer 蜂鸣器: AD16-22M △○ 闪光蜂鸣器: AD16-22SM △○</p>	 <p>Φ22 红绿双色灯 Φ22 Red and green double-color signal lamp AD16-22SS △</p>	
 <p>Φ22 接地位置指示灯 Φ22 Ground position indicator lamp AD16-22W/N △</p>	 <p>Φ22 断路器位置指示灯 Φ22 Breaker switch position indicator lamp AD16-22W/D △</p>	 <p>Φ22 隔离刀闸位置指示灯 Φ22 Isolating position indicator lamp AD16-22W/G △</p>	
 <p>Φ22 接地位置指示灯 Φ22 Ground position indicator lamp AD16-22WF/N △</p>	 <p>Φ22 断路器位置指示灯 Φ22 Breaker switch position indicator lamp AD16-22WF/D △</p>	 <p>Φ22 隔离刀闸位置指示灯 Φ22 Isolating position indicator lamp AD16-22WF/G △</p>	

Button Switch

YJ139-XB2 系列按钮开关
YJ139-XB2 Series Button Switch

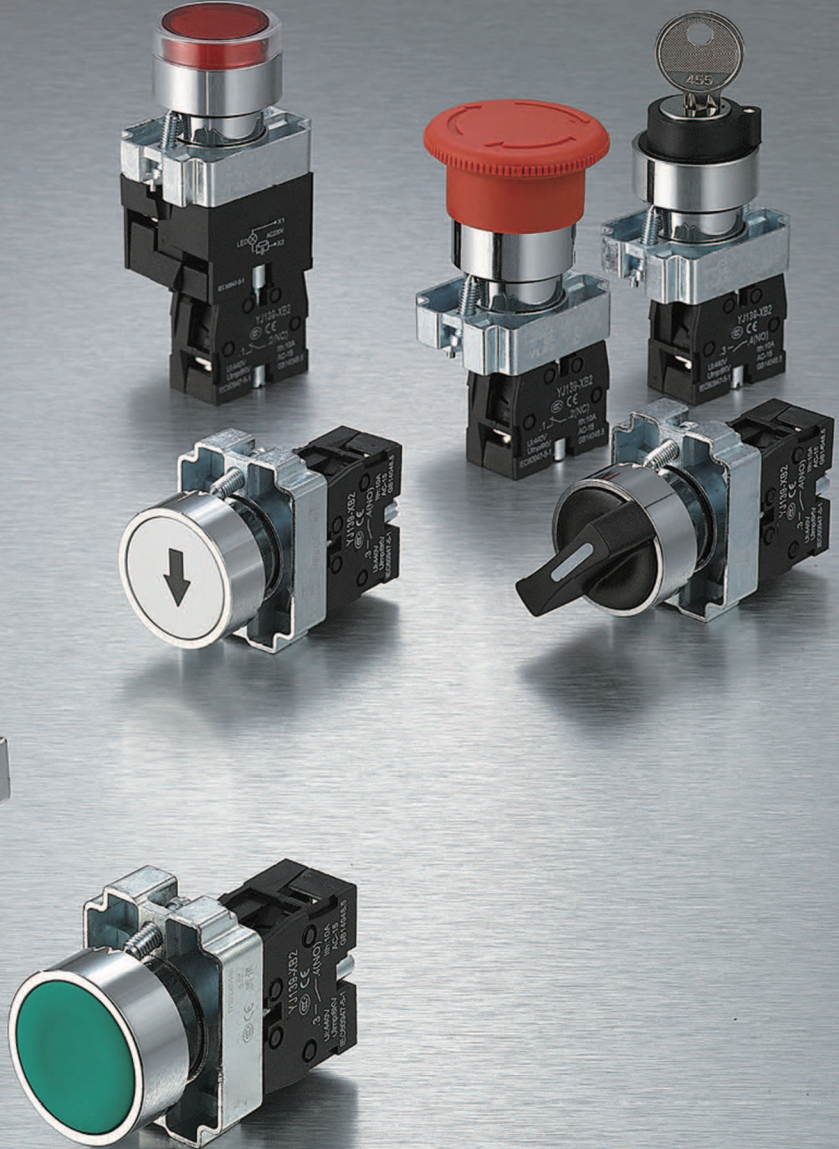
- 1. 安装孔尺寸: $\Phi 22$.
- 2. 开关额定值: Ui:440V, Ith:10A.
- 3. 机械寿命: ≥ 200 万次.
- 4. 电气寿命: ≥ 50 万次.
- 1. Installation dimensions: $\Phi 22$.
- 2. Rated voltage and current: Ui:440V, Ith:10A.
- 3. Mechanical life: $\geq 2,000,000$ times.
- 4. Electrical life: $\geq 500,000$ times.

复位平钮
Momentary push button
XB2- \odot BN \odot

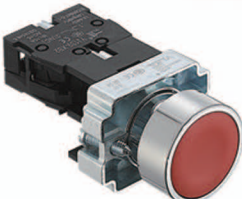

自锁平钮
Maintained push button
XB2- \odot BNZS \odot



带灯复位平钮
Illuminated Momentary push button
XB2- \odot DN Δ \odot



金角兽
JIN JIAO SHOU

全国服务热线: 4008-270-668

Product price list 产品价格表

Button Switch

YJ139-XB2 系列按钮开关 YJ139-XB2 Series Button Switch

触点结构 Contact	10/01/20/02/30/40/21/12/22/33	带灯电压 LED voltage	(AC/DC) 3V, 6V, 12V, 24V, 36V, 48V, 110V, 220V (AC) 110V, 220V, 380V	颜色 Color	R G Y B W BL
操作位置 Position	21: 二位置保持式 / 22: 二位置复位式 / 31: 三位置保持式 / 33: 三位置复位式 21: Two position maintained / 22: Two position momentary / 31: Three position maintained / 33: Three position momentary				



带灯自锁平钮
Illuminated Maintained push button
XB2- \odot DNZS Δ \odot



启动标志复位平钮
Start signal momentary push button
XB2- \odot BN/31

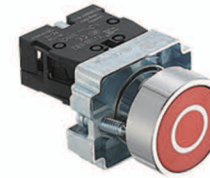

停止标志复位平钮
Stop signal momentary push button
XB2- \odot BN/32



黑色箭头标志复位平钮
Black arrow signal momentary push button
XB2- \odot BN/34

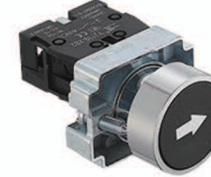

白色箭头标志复位平钮
White arrow signal momentary push button
XB2- \odot BN/35



双箭头标志蓝色复位平钮
Double arrow signal momentary blue push button
XB2- \odot BN/36



蘑菇头复位按钮
Mushroom momentary push button
XB2- \odot M \odot



蘑菇头自锁按钮
Mushroom maintained push button
XB2- \odot MZS \odot



急停按钮
Emergency push button
XB2- \odot ZS



旋钮
Selector switch
XB2- \odot X/ θ \odot



长柄旋钮
Long handle selector switch
XB2- \odot XB/ θ \odot

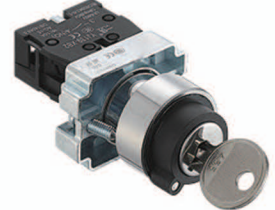

钥匙钮
key-lock selector switch
XB2- \odot Y/ θ

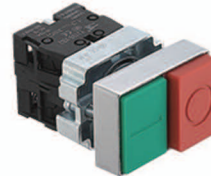

双位钮
Double head momentary push button
XB2- \odot B



双位带灯钮
Double head illuminated momentary push button
XB2- \odot D Δ



双向复位十字开关
Two position momentary cross-switch
XB2-PA22



Button Switch

YJ139-LA39 系列按钮开关 YJ139-LA39 Series Button Switch

触点结构 Contact	11/20/02/10/01/22/40/04/33	带灯电压 LED voltage	(AC/DC) 3V, 6V, 12V, 24V, 36V, 48V, 110V, 220V (AC) 110V, 220V, 380V	颜色 Color	R G Y B W BL
操作类型 Operation	无字母表示自复 / ZS: 自锁 No letter: momentary / ZS: maintained	操作位置 Position	21: 二位置保持式 / 22: 二位置复位式 / 31: 三位置保持式 / 33: 三位置复位式 / 32: 三位置左自锁右复位 21: Two position maintained / 22: Two position momentary / 22: Two position maintained / 22: Two position momentary / 31: Three position maintained / 31: Three position maintained / 31: Three position maintained / 32: Three position left maintained right momentary / 32: Three position left maintained right momentary		

Button Switch

YJ139-LA39 系列按钮开关 YJ139-LA39 Series Button Switch

1. 安装孔尺寸: $\Phi 22$.
2. 开关额定值: UI:440V, Ith:10A.
3. 机械寿命: ≥ 200 万次.
4. 电气寿命: ≥ 50 万次.
1. Installation dimensions: $\Phi 22$.
2. Rated voltage and current: UI:440V, Ith:10A.
3. Mechanical life: $\geq 2,000,000$ times.
4. Electrical life: $\geq 500,000$ times.

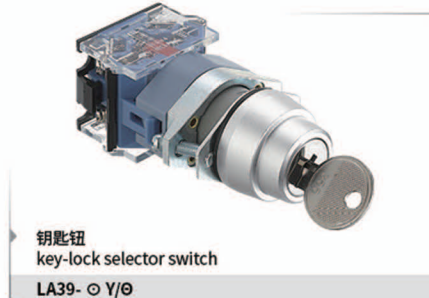
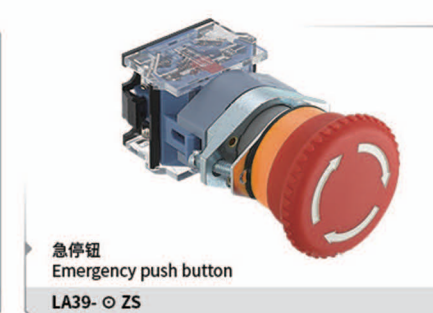
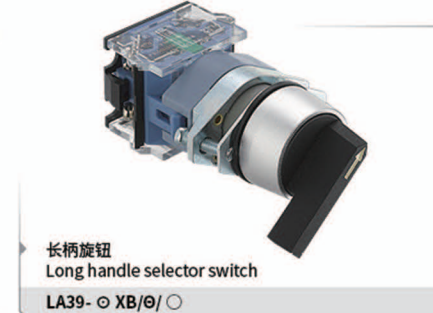
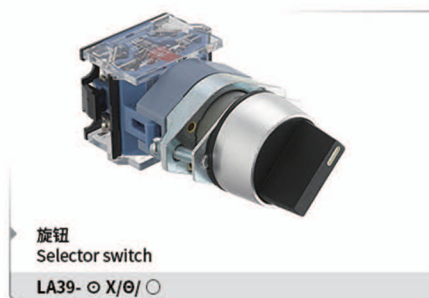
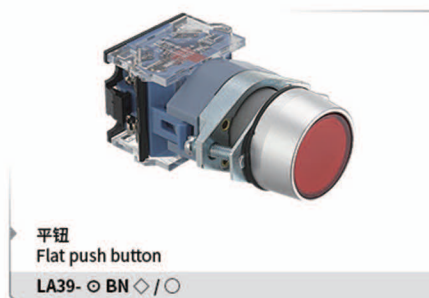
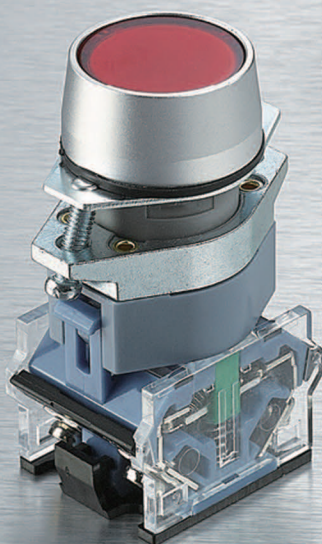
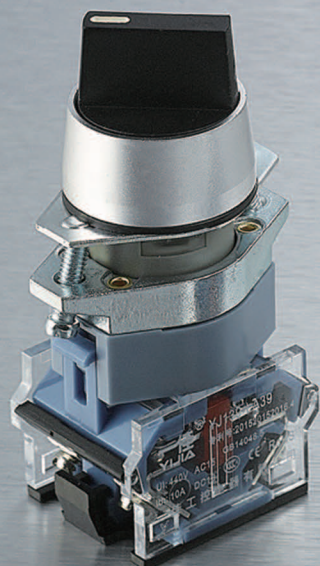
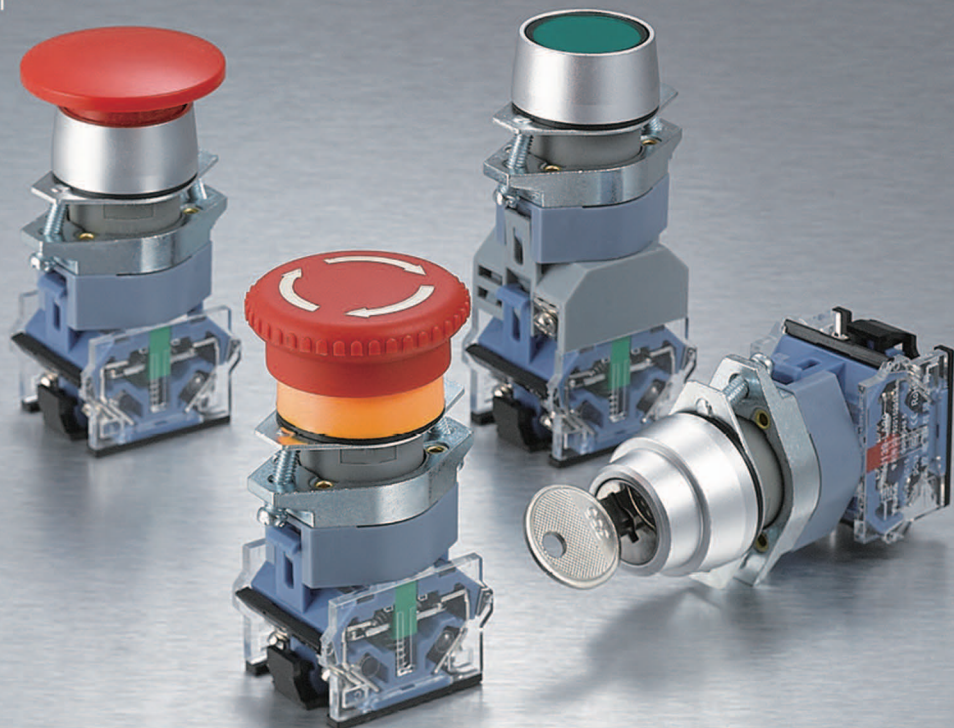

安装孔尺寸: Installation dimensions

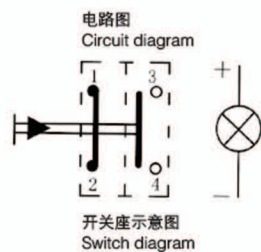
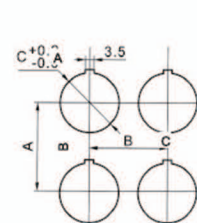

开关代号11
1, 2为常闭触头NC;
3, 4为常开触头NO;
Switch code:11
1,2 are normal closed
3,4 are normal opened

产品结构图示: Product structure chart

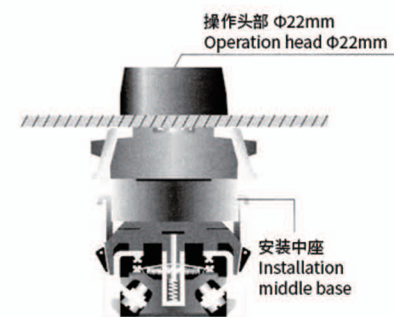

按钮类型 Pushbutton type	A	B	备注 Remarks
普通型 Normal type	> 50	> 35	1. 单位: mm 2. B和C均指最小尺寸
旋钮、钥匙 illuminated and key-lock	> 50	> 35	1. 单位: mm
蘑菇式 Mushroom	> 50	> 42	2. B and C both are minimum size

Button Switch

YJ139-LAY37 系列按钮开关
YJ139-LAY37 Series Button Switch

- 1. 安装孔尺寸: $\Phi 22$ 、 $\Phi 25$ 、 $\Phi 30$ 。
- 2. 开关额定值: $U_i: 440V$, $I_{th}: 10A$ 。
- 3. 机械寿命: ≥ 200 万次。
- 4. 电气寿命: ≥ 50 万次。
- 1. Installation dimensions: $\Phi 22$ 、 $\Phi 25$ 、 $\Phi 30$ 。
- 2. Rated voltage and current: $U_i: 440V$, $I_{th}: 10A$ 。
- 3. Mechanical life: $\geq 2,000,000$ times.
- 4. Electrical life: $\geq 500,000$ times.

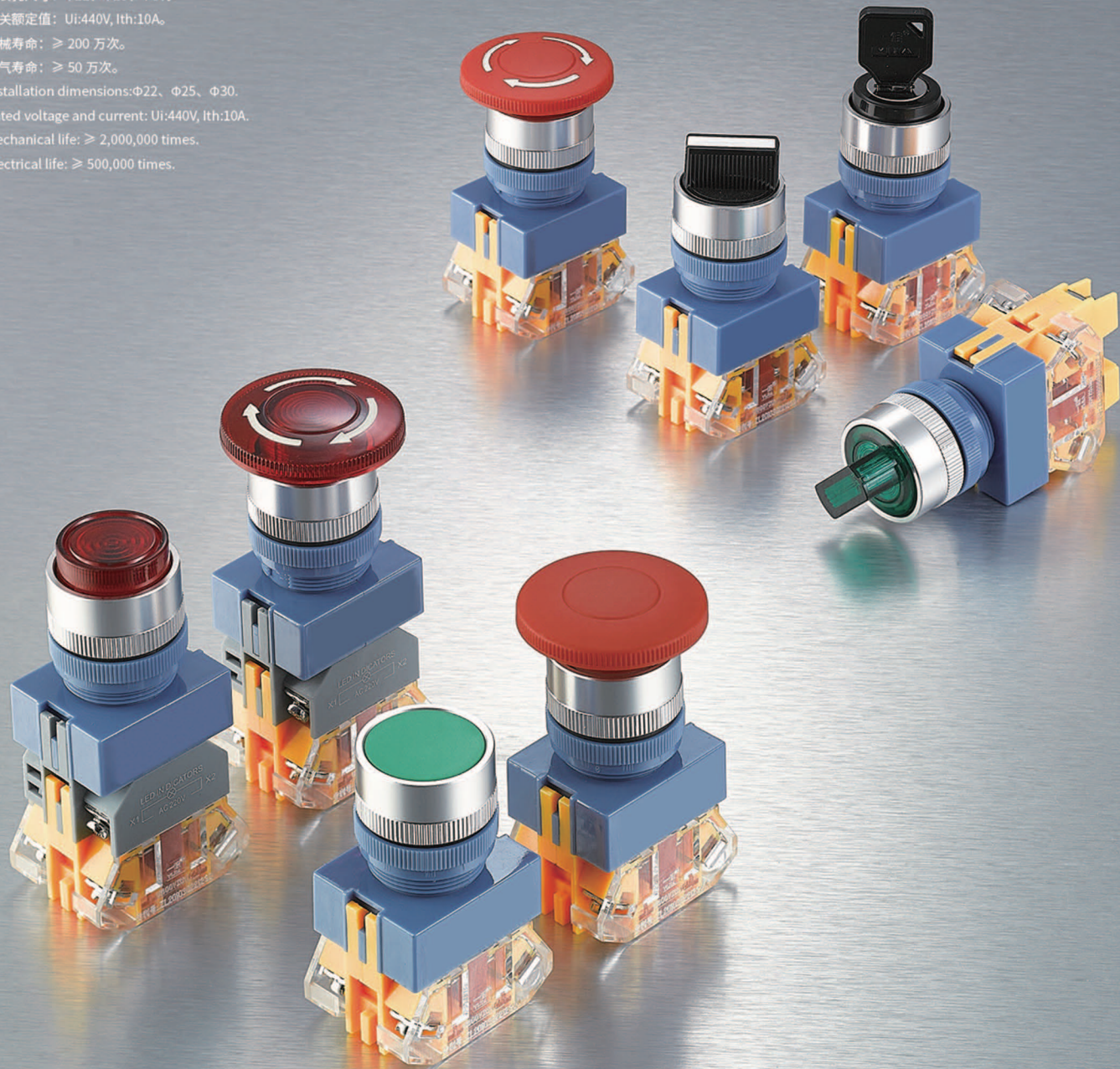

金角獸
JIN JIAO SHOU
☎ 4008-270-668



全国服务热线: 4008-270-668

Product price list 产品价格表

Button Switch

YJ139-LAY37 系列按钮开关 YJ139-LAY37 Series Button Switch

触点结构 Contact	11/20/02/10/01/22/40/04/33	带灯电压 LED voltage	(AC/DC) 3V, 6V, 12V, 24V, 36V, 48V, 110V, 220V (AC) 110V, 220V, 380V	颜色 Color	R G Y B W BL
操作类型 Operation	无字母表示自复 / ZS: 自锁 No letter: momentary / ZS: maintained	安装孔尺寸 Installation dimensions	无字母表示 $\Phi 22$ / $\Phi 25$ / $\Phi 30$ No letter: $\Phi 22$		
操作位置 Position	21: 二位置保持式 / 22: 二位置复位式 / 31: 三位置保持式 / 33: 三位置复位式 21: Two position maintained / 22: Two position momentary / 31: Three position maintained / 33: Three position momentary				

 <p>平钮 Flat push button □ LAY37-\odot BN \diamond / \odot</p>	 <p>高钮 High push button □ LAY37-\odot GN \diamond / \odot</p>	 <p>带灯高钮 High illuminated push button □ LAY37-\odot DN \diamond / Δ \odot</p>
 <p>带灯平钮 Flat illuminated push button □ LAY37-\odot DN \diamond / P Δ \odot</p>	 <p>旋钮 Selector switch □ LAY37-\odot X/θ / \odot</p>	 <p>长柄旋钮 Long handle selector switch □ LAY37-\odot XB/θ / \odot</p>
 <p>带灯旋钮 Illuminated selector switch □ LAY37-\odot XD/θ / Δ \odot</p>	 <p>蘑菇头按钮 Mushroom push button □ LAY37-\odot M \diamond / \odot</p>	 <p>蘑菇头带灯按钮 Mushroom illuminated push button □ LAY37-\odot M \diamond D / Δ \odot</p>
 <p>急停钮 Emergency push button □ LAY37-\odot ZS</p>	 <p>带灯急停钮 Illuminated emergency push button □ LAY37-\odot ZSD Δ</p>	 <p>钥匙钮 Key-lock selector switch □ LAY37-\odot Y/θ</p>
 <p>信号灯 Signal lamp □ LAY37-SLC Δ \odot</p>		



Button Switch

YJ-LA12 系列按钮开关 YJ-LA12 Series Button Switch

⊙ 触点结构 Contact	11: 一常开+一常闭; 22: 二常开+二常闭 11: 1NO1NC; 22: 2NO2NC	△ 带灯电压 LED voltage	1.8V、3V、6V、12V、24V、36V、48V、 110V、220V、380V	○ 颜色 Color	R G Y B W BL
◇ 操作类型 Operation	无字母表示自复 / ZS: 自锁 No letter: momentary / ZS: maintained				

15 Button Switch

YJ-LA12 系列按钮开关 YJ-LA12 Series Button Switch

1. 安装孔尺寸: $\Phi 12$.
2. 头部形状: 圆形、正方形、长方形。
3. 开关额定值: $U_i: 250VAC, I_{th}: 5A$ 。
4. 机械寿命: ≥ 50 万次。
5. 电气寿命: ≥ 10 万次
1. Installation dimensions: $\Phi 12$.
2. The shape of head: round, square, rectangle.
3. Rated voltage and current: $U_i: 250VAC, I_{th}: 5A$.
4. Mechanical life: $\geq 500,000$ times.
5. Electrical life: $\geq 100,000$ times



注意事项: Matters needing attention

1. 接线: 在 20W/5 秒或 260°C /3 秒以内焊接端子, 不施加外力给端子。焊接时, 烙铁不要触及外壳。接线时, 要防止应力作用于端子上, 既不要弯曲或提升端子, 也不要向端子施加外力。
2. 对于自锁按钮, 在更换元件前应确保按钮处于释放位置, 如更换处于锁定位置的按钮可能会损坏内部机构!
3. 按钮用手操作, 严禁用其它器具替代操作!

1. Wiring connection: Finish soldering within 20W/5 sec or 260°C /3 sec. When soldering, soldering iron should not touch crust. Do not apply force on the terminal, neither rotate nor rise terminal, nor force on terminal.
2. In the lock state do not open the alternate type button; it could lead to internal structure damage.
3. When operating, do not use other tools instead hand.



金角獸
JIN JIAO SHOU
4008-270-668



全国服务热线：4008-270-668

Product price list 产品价格表

Button Switch

YJ-F16 系列按钮开关 YJ-F16 Series Button Switch

触点结构 Contact	11:一常开+一常闭; 22:二常开+二常闭; 33:三常开+三常闭 11:1NO1NC; 22:2NO2NC; 33:3NO3NC	带灯电压 LED voltage	1.8V、3V、6V、12V、24V、36V、48V、 110V、220V、380V	颜色 Color	R G Y B W BL
操作类型 Operation	无字母表示自复 / ZS: 自锁 No letter: momentary / ZS: maintained	操作位置 Position	21: 二位置保持式 / 22: 二位置复位式 / 31: 三位置保持式 / 33: 三位置复位式 21: Two position maintained / 22: Two position momentary / 31: Three position maintained / 33: Three position momentary		

16 Button Switch

YJ-F16 系列按钮开关 YJ-F16 Series Button Switch

1. 安装孔尺寸: $\Phi 16$ 。
2. 结构特点: 模块化小按钮, 开关座可与操作部位分离, 触点结构可自由组合。
3. 头部形状: 圆形、正方形、长方形。
4. 开关额定值: $U_i: 250VAC, I_{th}: 5A$ 。
5. 机械寿命: ≥ 100 万次。
6. 电气寿命: ≥ 50 万次。

1. Installation dimensions: $\Phi 16$.
2. Structural features: modularization, contact can be separated from the operation part, contact can be freely combined.
3. The shape of head: round, square, rectangle.
4. Rated voltage and current: $U_i: 250VAC, I_{th}: 5A$.
5. Mechanical life: $\geq 1,000,000$ times.
6. Electrical life: $\geq 500,000$ times.

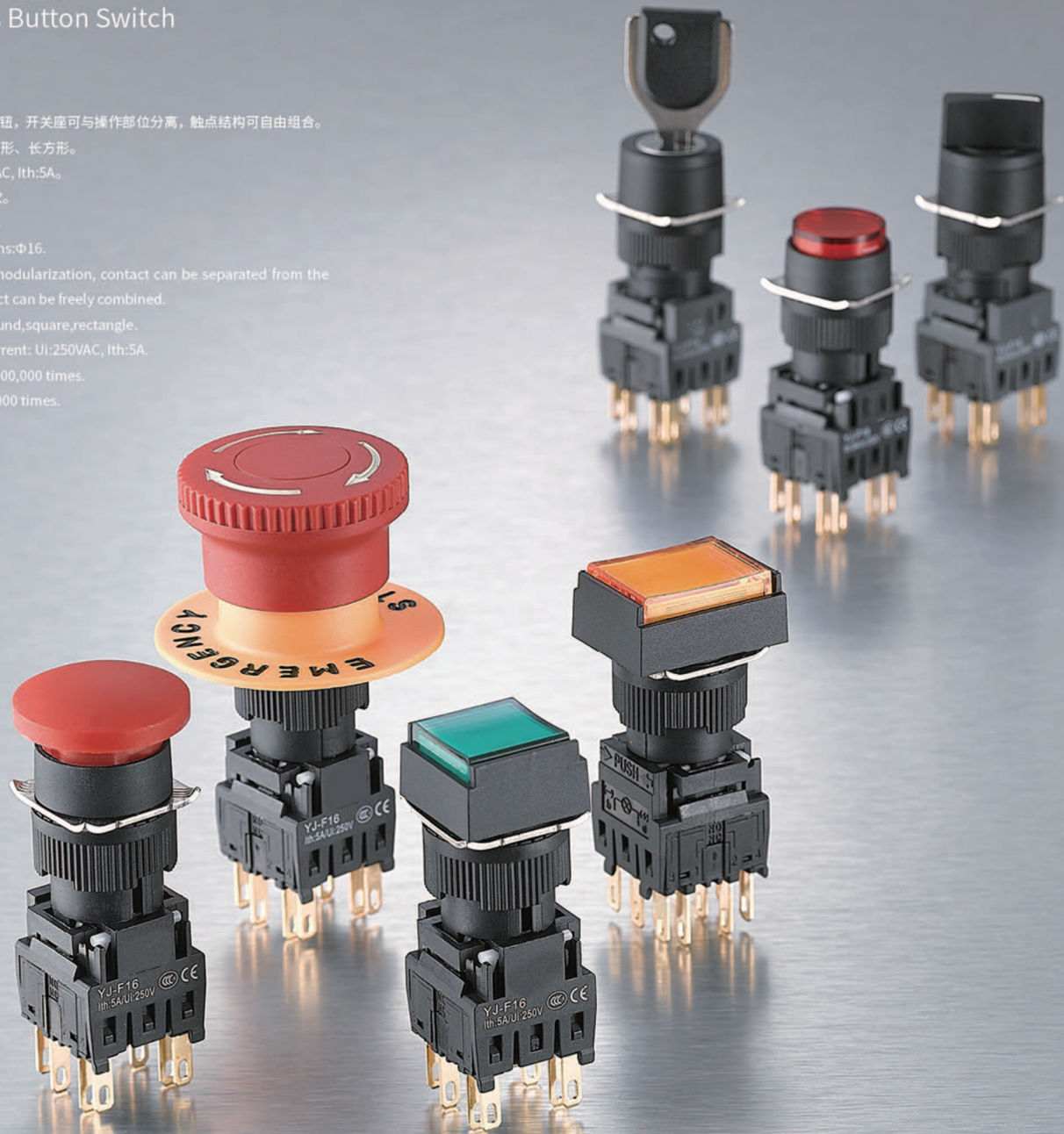

 圆形按钮 round push button F16Y- \circ BN \diamond \circ	 方形按钮 square push button F16F- \circ BN \diamond \circ	 矩形按钮 rectangle push button F16J- \circ BN \diamond \circ
 圆形带灯按钮 round illuminated push button F16Y- \circ DN \diamond Δ \circ	 方形带灯按钮 square illuminated push button F16F- \circ DN \diamond Δ \circ	 矩形带灯按钮 rectangle illuminated push button F16J- \circ DN \diamond Δ \circ
 蘑菇头按钮 Mushroom push button F16- \circ M \diamond \circ	 急停按钮 Emergency push button F16- \circ ZS	
 圆形旋钮 round selector switch F16Y- \circ X/ \emptyset	 方形旋钮 square selector switch F16F- \circ X/ \emptyset	 矩形旋钮 rectangle selector switch F16J- \circ X/ \emptyset
 圆形钥匙按钮 round key-lock selector switch F16Y- \circ Y/ \emptyset	 方形钥匙按钮 square key-lock selector switch F16F- \circ Y/ \emptyset	 矩形钥匙按钮 rectangle key-lock selector switch F16J- \circ Y/ \emptyset



Accessories

按钮开关附件 Button switch accessories

		
Φ12 金属按钮防水罩 Φ12 Waterproof cover of metal button F12-1	Φ16 方形防护罩 Φ16 Square protection cover F16-1/F	Φ16 矩形防护罩 Φ16 Rectangular protection cover F16-1/J
		
Φ16 圆形防水罩 Φ16 Round waterproof cover F16-2/Y	Φ16 方形防水罩 Φ16 Square waterproof cover F16-2/F	Φ16 矩形防水罩 Φ16 Rectangular waterproof cover F16-2/J
		
Φ16 面板塞 Φ16 Panel plug F16-3	Φ16 灯珠 (适配 LA16 系列) Φ16 LED lamp(LA16 series) F16-4	Φ16 警告圈 Φ16 Warning circle F16-5
		
Φ16 标牌框 Φ16 Scutcheon F16-6	Φ16 小头急停按钮无边防护座 Φ16 Emergency protect base F16-7	Φ16 小头急停按钮有边防护座 Φ16 Emergency protect base F16-8
		
Φ16 金属按钮防护罩 Φ16 Protection cover of metal button F16-9	Φ16 急停按钮防护罩 (50*33) Φ16 Emergency protect cover F16-10	Φ16 金属按钮防水罩 Φ16 Waterproof cover of metal button F16-11

Accessories

按钮开关附件 Button switch accessories

1. 适配孔径：Φ12、Φ16、Φ19、Φ22。
2. 作用：防水、防尘、防误操作、指示、警告、协助安装等。
1. Suitable dimensions: Φ12、Φ16、Φ19、Φ22.
2. Function: waterproof, dustproof, prevent operating errors, instructions, warnings, assistance installation, etc.



Button Box

YJX 系列按钮盒
YJX Series Button Box

- 盖与座连接:
4 颗 M4 不锈钢自攻螺丝。
 - 材料: 阻燃 ABS。
 - 温度范围: $-50^{\circ}\text{C} \sim +120^{\circ}\text{C}$ 。
 - 防护等级: IP65。
- Cover and base connection:
Four M4 stainless steel tapping screws.
 - Material: Flame retardant ABS.
 - Temperature: $-50^{\circ}\text{C} \sim +120^{\circ}\text{C}$.
 - IP degree: IP65.

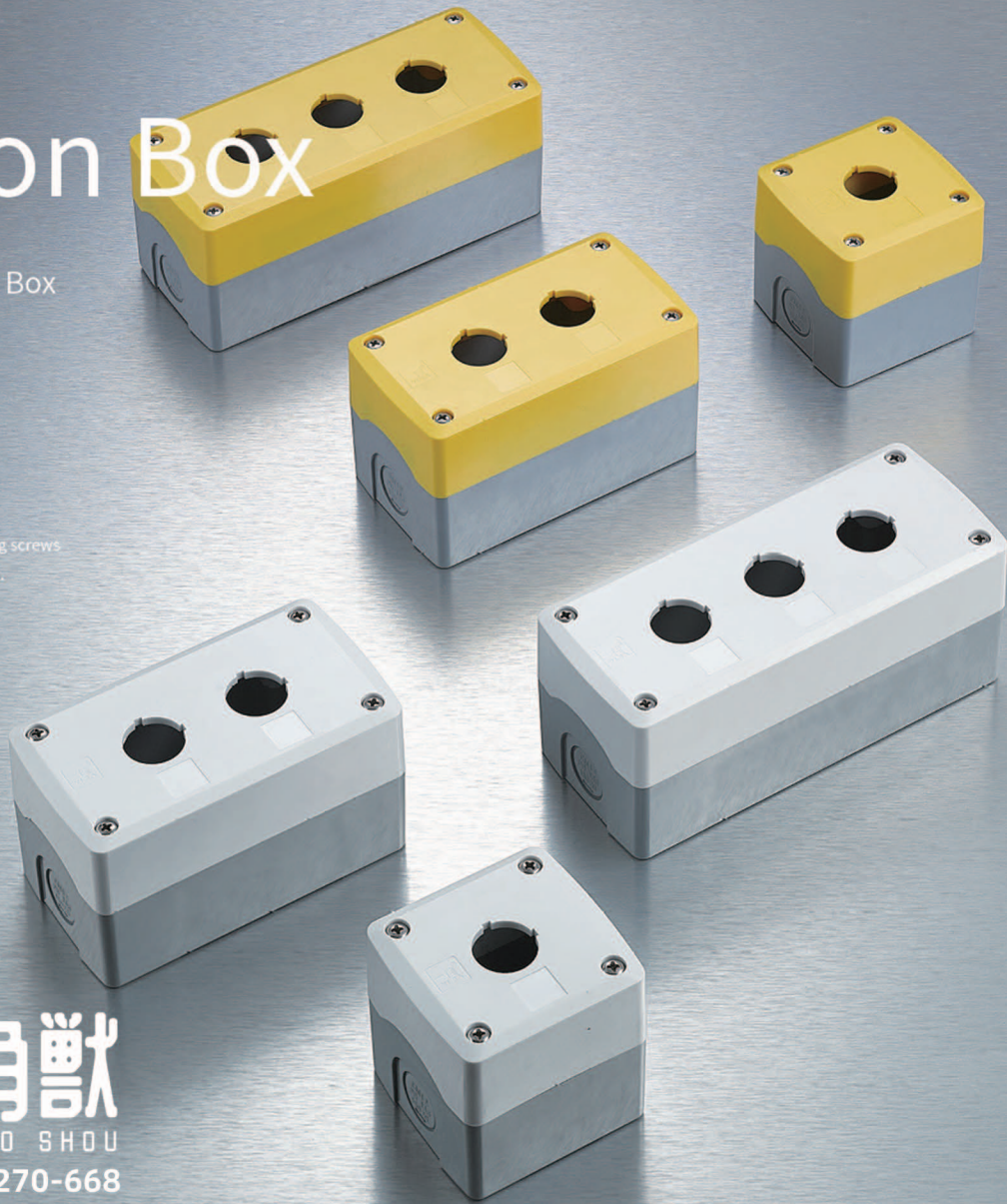

金角獸
JIN JIAO SHOU
4008-270-668



Accessories

按钮开关附件 Button switch accessories

