



国家气动产品质量监督检验中心  
National Quality Supervision and Inspection  
Center of Pneumatic Products (NCPP)

# 东莞天米智能装备科技有限公司

 4008-270-668

手机1: 134-1222-6797

手机2: 186-8005-2736

网址: [www.goldenhorn.cn](http://www.goldenhorn.cn)

地址: 广东省东莞市莞城区八达电子城 1 号

“金角兽”机械自动化设备控制系统产品提供商, 更多产品详情介绍登入网站

网址: [www.goldenhorn.cn](http://www.goldenhorn.cn)



扫码进入商城



咨询客服1



咨询客服2



**金角獸**  
JIN JIAO SHOU  
☎ 4008-270-668

让气动采购更简单

130+ 品种

20000+ 规格

5%-60%

采购成本节省

产品价目表 2020B





金角獸  
JIN JIAO SHOU  
☎ 4008-270-668

ALL CATEGORIES  
AVAILABLE FROM STOCK

全品类 现货供应



气源  
Gas Source



气缸  
Cylinder



阀类  
Cylinder



气管  
Trachea



接头  
Joint



真空  
Vacuum

140 140 多个品种

2W 20000 多个规格

1200 W 1200 万元 现货供应

金角獸自动化 让气动采购更简单。



# 金角獸

JIN JIAO SHOU

☎ 4008-270-668

让气动采购更简单

**STRONG  
SUPPLY CHAIN**

## 强大的供应链

**FESTO**

德国费斯托

**CKD**

日本CKD

 **NORGREN**

英国诺冠

**AIRTAC**

台湾亚德客

**DELIXI**

中国德力西

 <sup>®</sup> 星辰  
XING



# COMPAY PROFILE

## 公司简介

金角兽是集研发、制造、销售为一体的专业气动元件生产企业，专业生产滑台气缸、无杆气缸、旋转气缸、手指气缸、摆动气缸、金属按钮开关、波纹管、尼龙拖链等高端产品。公司本着顾客至上，精益求精的经营理念，不断壮大发展，在不断加强产品的质量管理及信售后服务的同时，还非常注重科技人才的培养和科研事业的投入。现已拥有专业的研发的精良队伍。自创办以来，力求产品的不断创新，以品质优良，品种繁多，外形新颖，价格合理，服务完善的特点赢得了广大客户的信任和赞誉。

金角兽凭着认真，负责及积极热情地态度，将会在气动工业领域里，开创一片更为广阔的天地。本公司热忱欢迎您的加盟，一同携手耕耘，共创精彩人生。全国服务热线：4008-270-688

Jinjiaozhen is a professional pneumatic component manufacturer integrating R & D, manufacturing and sales, specializing in the production of high-end products such as slide cylinder, Rodless cylinder, rotary cylinder, finger cylinder, swing cylinder, metal button switch, bellows, nylon drag chain, etc. In line with the business philosophy of customer first and striving for improvement, the company has been constantly expanding and developing. While continuously strengthening the quality management and after-sales service of products, it also attaches great importance to the cultivation of scientific and technological talents and the investment in scientific research. Now we have a professional R & D team. Since its establishment, we have been striving for continuous innovation of our products. We have won the trust and praise of our customers for their excellent quality, wide variety, novel appearance, reasonable price and perfect service.

With a serious, responsible and enthusiastic attitude, golden horn will create a broader world in the field of pneumatic industry. We warmly welcome you to join us and work together to create a wonderful life. National Service Hotline: 4008-270-688

让气动采购更简单



金角兽  
JIN JIAO SHOU  
4008-270-668

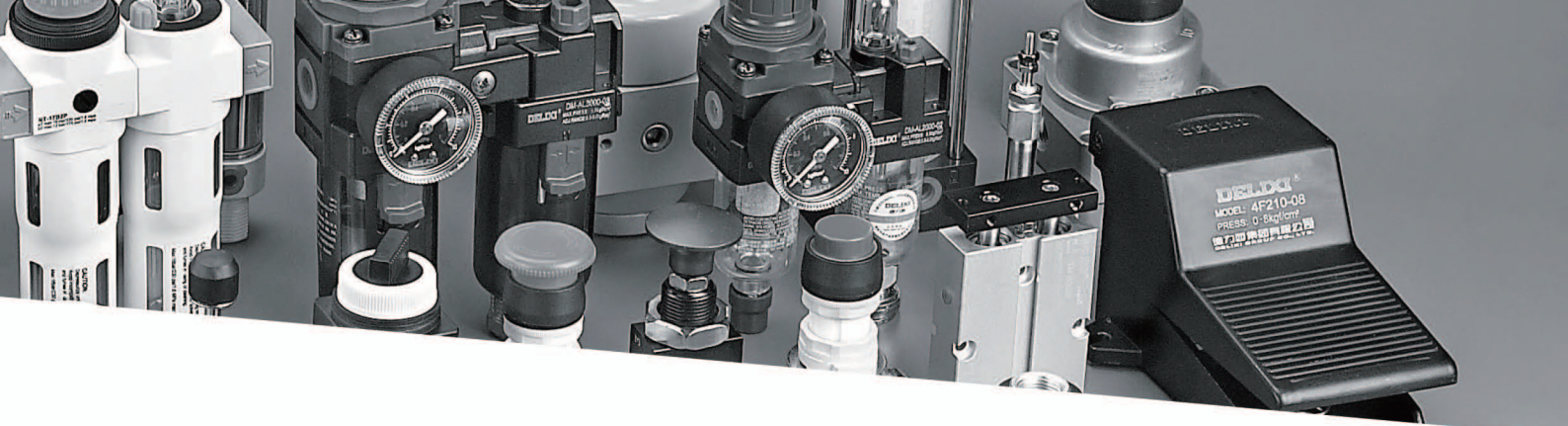

# CHOOSE US

## 选择我们



**金角獸**  
JIN JIAO SHOU  
☎ 4008-270-668

### 货物齐全



多

8大系列、100多个品种、20000多个型号、12000000元现货库存；包含气源处理件、气动阀、气缸、气爪、气动接头、气动辅材、真空等多种产品。

### 在线查价查库查图



快

免费 APP **10秒**查价查库查图，如同在自己仓库，快速了解所需型号库存、价格、产品图等数据，报价发图比同行快 **2/3** 以上，抢占先机

### 采购更便宜



省

优选产业带实力厂家，大单集供集采，摊薄成本  
采购价格下浮 **5%-60%**



气源



## 处理元件

SMC 型、亚德客型、费斯托型、CKD 型  
Q 系列气源、调压阀、过滤器、调压过滤器  
两联件、三联件、油雾器



**金角獸**  
JIN JIAO SHOU  
☎ 4008-270-668

# CONTENTS

## 目录



# 金角獸

JIN JIAO SHOU

☎ 4008-270-668



01 SMC 型新款气源



02 精密调压阀



02 SMC 气源附件



03 CKD 型气源



04 CKD 气源附件



04 亚德客型气源



05 山耐斯型气源



05 G 系列气源



06 SMC 型气源



06 电子排水器



06 排水器



07 Q 系列过滤器



07 39 系列气源



07 高精度高压过滤器



08 费斯托型气源



08 气压表 / 真空表





**金角獸**  
JIN JIAO SHOU  
☎ 4008-270-668

# AIR PROCESSOR EXPLOSION DIAGRAM

气源处理件结构爆炸图

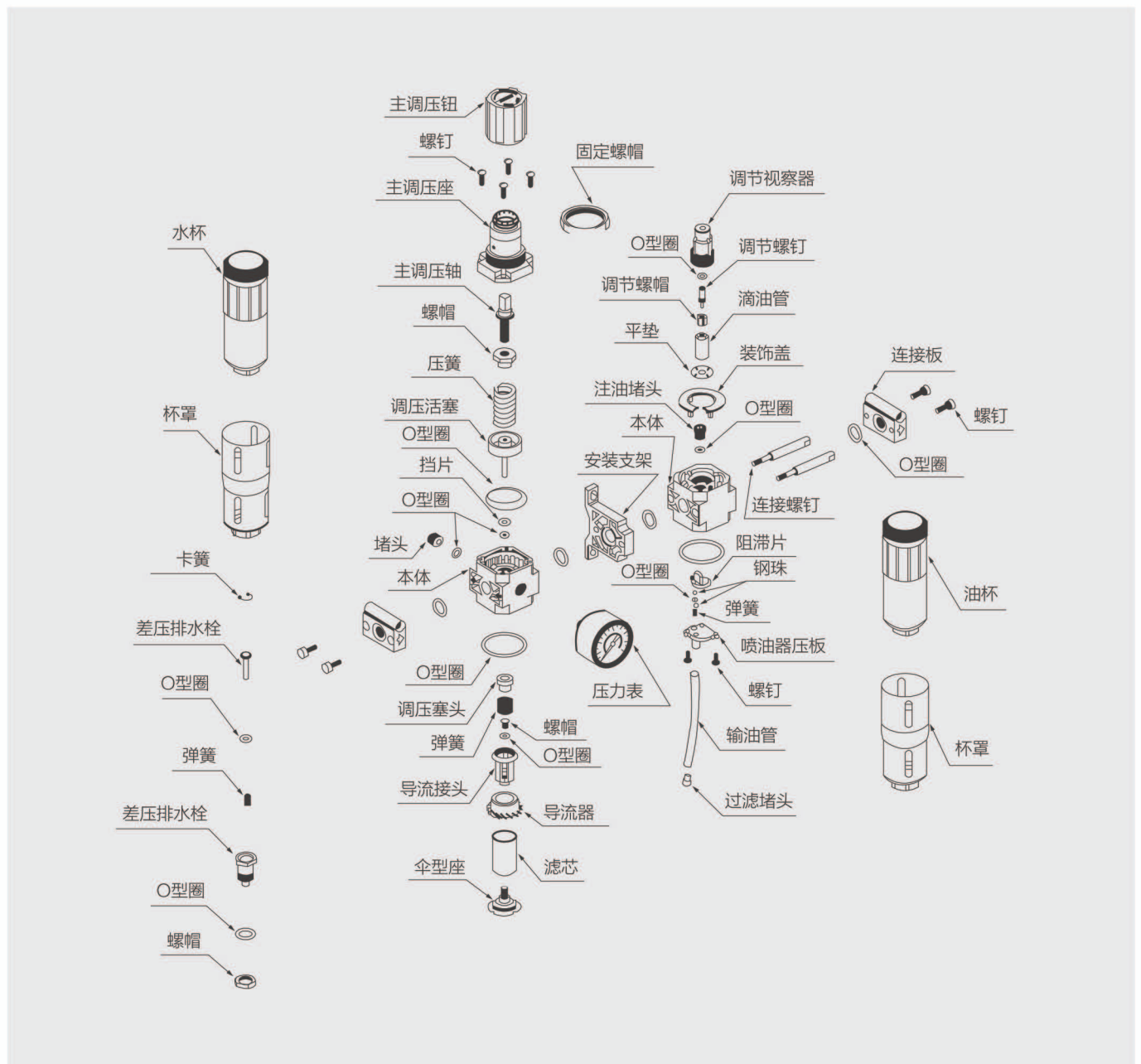

让气动采购更简单

外观、尺寸、功能  
替代日系气源

SMC 型新款气源

减压阀 AR 系列



型号	单价
AR10-M5	66.00
AR20-02	61.60
AR30-03	88.00
AR40-04	123.20
AR5000-06	154.00
AR20K-02	94.60
AR30K-03	127.60
AR40K-04	167.20

SL

SMC 型新款气源

油雾器 AL 系列



型号	单价
AL10-M5	55.00
AL20-02	44.00
AL30-03	66.00
AL40-04	92.40
AL5000-06	143.00

SL

减压过滤器 AW 系列



型号	单价
AW10-M5	88.00
AW20-02	70.40
AW30-03	123.20
AW40-04	187.00
AW5000-06	303.60
AW20-02D(自动排水)	110.00
AW30-03D(自动排水)	178.20
AW40-04D(自动排水)	253.00
AW5000-06D(自动排水)	352.00
AW20K-02(可逆型)	103.40
AW30K-03(可逆型)	162.80
AW40K-04(可逆型)	231.00
AW20K-02D (可逆自动排水)	143.00
AW30K-03D (可逆自动排水)	215.60
AW40K-04D (可逆自动排水)	297.00

SL

油水分离器 AFM 系列



型号	单价
AFM20-02	88.00
AFM30-03	118.80
AFM40-04	149.60
AFM20-02D(自动排水)	123.20
AFM30-03D(自动排水)	165.00
AFM40-04D(自动排水)	195.80

SL

高精度油水分离器 AFD 系列



型号	单价
AFD20-02	99.00
AFD30-03	129.80
AFD40-04	158.40
AFD20-02D(自动排水)	143.00
AFD30-03D(自动排水)	176.00
AFD40-04D(自动排水)	209.00

SL

标准三联件



型号	单价
AC10-M5	187.00
AC20-02	165.00
AC30-03	253.00
AC40-04	330.00
AC5000-06	528.00
AC20-02D(自动排水)	202.40
AC30-03D(自动排水)	297.00
AC40-04D(自动排水)	374.00
AC5000-06D(自动排水)	572.00

SL

过滤器 AF 系列



型号	单价
AF10-M5	44.00
AF20-02	33.00
AF30-03	55.00
AF40-04	88.00
AF5000-06	143.00
AF20-02D(自动排水)	79.20
AF30-03D(自动排水)	110.00
AF40-04D(自动排水)	143.00
AF5000-06D(自动排水)	198.00

SL

二级过滤调压



型号	单价
AC20C-02	224.40
AC30C-03	297.00
AC40C-04	415.80
AC20A-02D(自动排水)	319.00
AC30A-03D(自动排水)	385.00
AC40A-04D(自动排水)	495.00

SL

SMC 型新款气源

外观、尺寸、功能  
替代日系气源

标准二联件	型号	单价
	AC10A-M5	167.20
	AC20A-02	132.00
	AC30A-03	187.00
	AC40A-04	283.80
	AC5010-06	451.00
	AC20A-02D(自动排水)	165.00
	AC30A-03D(自动排水)	242.00
	AC40A-04D(自动排水)	341.00
	AC5010-06D(自动排水)	484.00

SL

精密减压阀	型号	单价
	IR1000-01BG	180.00
	IR1010-01BG	180.00
	IR1020-01BG	180.00
	IR2000-02BG	188.00
	IR2010-02BG	188.00
	IR2020-02BG	188.00
	IR3000-02BG	530.00
	IR3000-03BG	530.00
	IR3010-02BG	530.00
	IR3010-03BG	530.00
	IR3020-02BG	530.00
	IR3020-03BG	530.00
	IR3000-04BG	638.00
	IR3010-04BG	638.00
	IR3020-04BG	638.00

BLCH

二联件	型号	单价
	AC10B-M5	121.00
	AC20B-02	110.00
	AC30B-03	160.60
	AC40B-04	231.00
	AC20B-02D(自动排水)	158.40
	AC30B-03D(自动排水)	215.60
	AC40B-04D(自动排水)	286.00

SL

SMC 气源附件	型号	单价
	ARAW20 支架	6.60
	ARAW30 支架	6.60
	ARAW40 支架	11.00
	ALAF20 支架	6.60
	ALAF30 支架	6.60
	ALAF40 支架	11.00
	10 螺母	4.40
	20 螺母	4.40
	30 螺母	6.60
	40 螺母	8.80
	IR1000 支架	6.60
	IR2000 支架	8.80
	压力表 1分	11.00
	压力表 2分	17.60
	压力表 M5	22.00
连接支架 10	22.00	
连接支架 20	17.60	
连接支架 30	19.80	
连接支架 40	22.00	
连接支架 50	33.00	
连接支架 60	39.60	
压力感应开关 IS10	165.00	

SL

过滤调压二联件	型号	单价
	AC20D-02	176.00
	AC30D-03	264.00
	AC40D-04	363.00
	AC20D-02D(自动排水)	242.00
	AC30D-03D(自动排水)	358.60
	AC40D-04D(自动排水)	473.00

SL

CKD 型气源

外观、尺寸、功能  
替代日系气源

F 系列过滤器	型号	单价
	F1000-01	28.50
	F1000-02	28.50
	F2000-02	36.64
	F2000-03	36.64
	F3000-02	44.78
	F3000-03	44.78
	F4000-03	65.12
	F4000-04	65.12

DC

CKD 型气源

C 系列二联件	型号	单价
	C1010-01	109.90
	C1010-02	109.90
	C2010-02	138.38
	C2010-03	138.38
	C3010-02	162.80
	C3010-03	162.80
	C4010-03	219.78
	C4010-04	219.78

DC

R 系列过滤器	型号	单价
	R1000-01	52.92
	R1000-02	52.92
	R2000-02	63.50
	R2000-03	63.50
	R3000-02	77.34
	R3000-03	77.34
	R4000-03	91.98
	R4000-04	91.98

DC

C 系列三联件	型号	单价
	C1000-01	117.96
	C1000-02	117.96
	C2000-02	162.80
	C2000-03	162.80
	C3000-02	187.22
	C3000-03	187.22
	C4000-03	252.34
	C4000-04	252.34

DC

L 系列油雾器	型号	单价
	L1000-01	30.94
	L1000-02	30.94
	L3000-02	47.22
	L3000-03	47.22
	L4000-03	77.34
	L4000-04	77.34

DC

R 系列可逆流减压阀	型号	单价
	R1100-01	71.64
	R1100-02	71.64
	R2100-02	80.58
	R2100-03	80.58
	R3100-02	93.62
	R3100-03	93.62
	R4100-03	107.44
	R4100-04	107.44

DC

W 系列过滤减压阀	型号	单价
	W1000-01	73.26
	W1000-02	73.26
	W2000-02	85.48
	W2000-03	85.48
	W3000-02	105.82
	W3000-03	105.82
	W4000-03	142.46
	W4000-04	142.46

DC

W 系列可逆流过滤减压阀	型号	单价
	W1100-01	89.54
	W1100-02	89.54
	W2100-02	102.98
	W2100-03	102.98
	W3100-02	125.36
	W3100-03	125.36
	W4100-03	170.12
	W4100-04	170.12

DC

CDK 气源附件

L 型支架	型号	系列	单价
	B100	1000 系列	4.20
	B100	2000 系列	4.20
	B300	3000 系列	4.20
	B400	4000 系列	4.20

CDK 气源附件

T 型支架	型号	系列	单价
	B110	1000 系列	12.2
	B110	2000 系列	12.2
	B310	3000 系列	16.28
	B410	4000 系列	16.28

压力表	型号	单价
	GS-27	14.66

全自动排水装置	型号	单价
	D2000	47.22
	D3000	44.78
	D4000	44.78

亚德客型气源

性价比高

三联件	型号	经济款	白色款	黑红款
	AC2000	44.00	46.00	48.00
	BC2000	80.00	84.00	88.00
	BC3000	80.00	84.00	88.00
	BC4000	80.00	84.00	88.00

二联件	型号	经济款	白色款	黑红款
	AFC2000	30.00	31.00	32.00
	BFC2000	60.00	70.00	72.00
	BFC3000	60.00	70.00	72.00
	BFC4000	60.00	70.00	72.00

过滤器	型号	经济款	白色款	黑红款
	AF2000	12.00	13.00	14.00
	BF2000	30.00	32.00	34.00
	BF3000	30.00	32.00	34.00
	BF4000	30.00	32.00	34.00

调压过滤器	型号	经济款	白色款	黑红款
	AFR2000	21.00	24.00	25.00
	BFR2000	40.00	46.00	48.00
	BFR3000	40.00	46.00	48.00
	BFR4000	40.00	46.00	48.00

注：经典款配置：铁表 + 黄色滤芯 + 黑色电泳 + 塑料杯罩；  
白色款配置：铁表 + 黄色滤芯 + 白色喷塑 + 金属杯罩；  
黑红款配置：铁表 + 黄铜滤芯 + 雅黑喷塑 + 金属杯罩。

调压阀	型号	经济款	白色款	黑红款
	AR2000	15.60	17.00	17.60
	BR2000	24.00	25.00	26.00
	BR3000	24.00	25.00	26.00
	BR4000	24.00	25.00	26.00

SA

油雾器	型号	经济款	白色款	黑红款
	AL2000	12.00	13.00	14.00
	BL2000	30.00	32.00	34.00
	BL3000	30.00	32.00	34.00
	BL4000	30.00	32.00	34.00

SA

注：自动排水型：A 系列 +24 元；B 系列 +40 元。

### 山耐斯型气源

山耐斯型气源	规格	单价
<p>二联件</p> <p>调压过滤器</p>	SFC200	90.00
	SFC300	90.00
	SFC400	90.00
	SFR200	54.00
	SFR300	54.00
	SFR400	54.00

SA

### G 系列气源

G 系列气源	型号	单价
	GFC200-06	85.80
	GFC200-08	85.80
	GFC300-08	154.00
	GFC300-10	154.00
	GFC300-15	154.00
	GFC400-10	242.00
	GFC400-15	242.00
	GFR200-06	57.20
	GFR200-08	57.20
	GFR300-08	92.40
	GFR300-10	92.40
	GFR300-15	92.40
	GFR400-10	158.40
	GFR400-15	158.40
	GL200-06	26.40
	GL200-08	26.40
	GL300-08	52.80
	GL300-10	52.80
	GL300-15	52.80
	GL400-10	96.80
GL400-15	96.80	
GR200-06	46.20	
GR200-08	46.20	
GR300-08	59.40	
GR300-10	59.40	
GR300-15	59.40	
GR400-10	118.80	
GR400-15	118.80	

SM

### G 系列气源

G 系列气源	型号	单价
	GC200-06	105.60
	GC200-08	105.60
	GC300-08	193.60
	GC300-10	193.60
	GC300-15	193.60
	GC400-10	303.60
	GC400-15	303.60
	GF200-06	26.40
	GF200-08	26.40
	GF300-08	52.80
	GF300-10	52.80
	GF300-15	52.80
	GF400-10	96.80
	GF400-15	96.80

SM

SMC 型气源

AF 系列过滤器	型号	普通款	白色款
	AF2000-02	14.40	19.02
	AF3000-02	26.74	34.70
	AF3000-03	26.74	34.70
	AF4000-04	43.18	54.92
	AF4000-06	47.30	59.44
	AF5000-06	84.32	103.34
AF5000-10	84.32	103.34	

AW 系列调压过滤器	型号	普通款	白色款
	AW2000-02	34.96	44.40
	AW3000-02	53.46	66.86
	AW3000-03	53.46	66.86
	AW4000-04	92.54	111.96
	AW4000-06	96.66	116.50
	AW5000-06	146.00	173.96
AW5000-10	146.00	173.96	

AC 系列三联件	型号	普通款	白色款
	AC2000-02	67.86	80.58
	AC3000-02	108.98	127.94
	AC3000-03	108.98	127.94
	AC4000-04	183.02	211.50
	AC4000-06	197.42	227.34
	AC5000-06	285.84	327.78
AC5000-10	285.84	327.78	

AC 系列二联件	型号	普通款	白色款
	AC2010-02	57.58	69.28
	AC3010-02	92.00	100.00
	AC3010-03	92.00	100.00
	AC4010-04	139.84	164.00
	AC4010-06	148.06	173.04
	AC5010-06	252.94	291.58
AC5010-10	252.94	291.58	

AR 系列调压阀	型号	普通款	白色款
	AR2000-02	26.74	32.16
	AR3000-02	41.12	48.00
	AR3000-03	41.12	48.00
	AR4000-04	71.98	81.92
	AR4000-06	76.08	86.46
	AR5000-06	98.70	111.34
AR5000-10	98.70	111.34	

AL 系列油雾器	型号	普通款	白色款
	AL2000-02	16.46	18.10
	AL3000-02	30.84	33.94
	AL3000-03	30.84	33.94
	AL4000-04	44.42	48.86
	AL4000-06	47.30	52.02
	AL5000-06	87.40	96.14
AL5000-10	87.40	96.14	

注：经济型配置：喷漆灰绿色 + 纤维滤芯 + 铁表；  
 白色款配置：喷漆白色 + 黄铜滤芯 + 铜表；  
 自动排水：2000 系列 +26 元；3000 系列 +34 元；  
 4000、5000 系列 +39 元。

电子排水器	规格	单价
	电排分体	90.00
	电排整体	90.00
	线圈	25.08
	定时器	31.36
	引出线接头	10.46

排水器	规格	单价
	AD402	60.00
	DF-404	46.00
	AS6D	80.00
	PA68	140.00
	PB68	160.00
	VR20A	44.00
	VR20B	36.00
	VR20C	90.00
	VR20D	100.00
	VR20T	50.00
VR98	240.00	

Q 系列气源

Q 系列高压型过滤器	型号	单价
 高压型	QTYH-8 高压型	84.80
	QTYH-15 高压型	84.80
	QTYH-20 高压型	212.00
	QTYH-25 高压型	212.00
	QTYH-32 高压型	498.20
	QTYH-40 高压型	498.20
	QTYH-50 高压型	561.80
	QFRH-8 高压型	356.16
	QFRH-10 高压型	356.16
	QFRH-15 高压型	356.16
	QFRH-20 高压型	589.36
	QFRH-25 高压型	589.36
	QSLH-8 高压型	137.80
	QSLH-10 高压型	137.80
	QSLH-15 高压型	137.80
QSLH-20 高压型	286.20	
QSLH-25 高压型	286.20	

HA

39 系列气源	型号	单价
	395-25	105.60
	394-25	85.80
	396-25	83.60
	397-25	143.00
	398-25	259.60
	399-25	226.60
	394-15	41.80
	395-15	55.00
	396-15	41.80
	397-15	83.60
	398-15	127.60
	399-15	116.60
	394-8	22.00
	395-8	26.40
	396-8	26.40
397-8	50.60	
398-8	77.00	
399-8	70.40	

Q 系列气源

Q 系列过滤器	型号	单价
	QTY-8 调压阀	46.64
	QTY-10 调压阀	46.64
	QTY-15 调压阀	46.64
	QTY-20 调压阀	89.04
	QTY-25 调压阀	89.04
	QTY-32 调压阀	133.56
	QTY-40 调压阀	133.56
	QTY-50 调压阀	133.56
	QSL-8 过滤器	43.46
	QSL-10 过滤器	43.46
	QSL-15 过滤器	43.46
	QSL-20 过滤器	69.96
	QSL-25 过滤器	69.96
	QSL-32 过滤器	133.56
	QSL-40 过滤器	133.56
	QSL-50 过滤器	133.56
	QIU-8 油雾器	44.52
	QIU-10 油雾器	44.52
	QIU-15 油雾器	44.52
	QIU-20 油雾器	72.08
	QIU-25 油雾器	72.08
	QIU-32 油雾器	126.32
	QIU-40 油雾器	126.32
QIU-50 油雾器	126.32	

HA

海沃斯型精密过滤器	规格	口径	单价
	015-04 铝壳	3/4	54.00
	024-06 铁壳	1 寸	67.00
	024-06 铝壳	1 寸	83.00
	035-40 铝壳	1.5 寸	83.00
	070-40 铁壳	1.5 寸	108.00
	090-62 铁壳	2.5 寸	269.00
	120-62 铁壳	2.5 寸	325.00
	150-62 铁壳	2.5 寸	403.00

WG

油雾器专用油	规格	单价
	SLY-01	26.00

SC



## 费斯托型气源

B 系列费斯托型气源 (无杯罩, 经济型)	产品型号	MINI (迷你)	MIDI( 中长)
		1/8、1/4、3/8	1/4、3/8、1/2、3/4
	二联件 HFC	117.60	196.00
	过滤减压阀 HFR	72.80	137.20
	过滤器 HF	42.00	76.16
	油雾器 HL	53.20	78.40

D 系列费斯托型气源	产品型号	MINI (迷你)	MIDI( 中长)	MAXI( 最大)
		1/8、1/4、3/8	1/4、3/8、1/2、3/4	1/2、3/4、1"
	三联件 HC	154.00	252.00	548.80
	二联件 HFC	134.40	215.60	386.40
	过滤减压阀 HFR	81.20	145.60	277.20
	减压阀 HR	67.20	114.80	224.00
	过滤器 HF	50.40	86.24	201.60
	油雾器 HL	60.48	87.92	201.60
	调压过滤器			

## 气压表 / 真空表

气压表	型号	规格	单价
	Y-40( 径向)	气压表 40 表盘 M10*1 螺纹 0-1Mpa	12.00
	Y-40ZT( 轴向)	气压表 40 表盘 M10*1 螺纹 带法兰 0-1Mpa	16.00
	Y-40ZU( 轴向)	气压表 40 表盘 M10*1 螺纹 带支架 0-1Mpa	17.00
	Y-50ZT( 轴向)	气压表 50 表盘 M14*1.5 螺纹 带法兰 0-1Mpa	18.00
	Y-50ZU( 轴向)	气压表 50 表盘 M14*1.5 螺纹 带支架 0-1Mpa	20.00

真空表	型号	规格	单价
	Y-60ZT-1/4( 轴向)	真空表 60 表盘 1/4 螺纹 带法兰 -0.1-0Mpa	17.00
	Y-60ZT-1/8( 轴向)	真空表 60 表盘 1/8 内螺纹 带法兰 -0.1-0Mpa	17.00
	Y-60ZT-V( 轴向)	真空表 60 表盘 1/8 螺纹 带法兰 -0.1-0Mpa	17.00

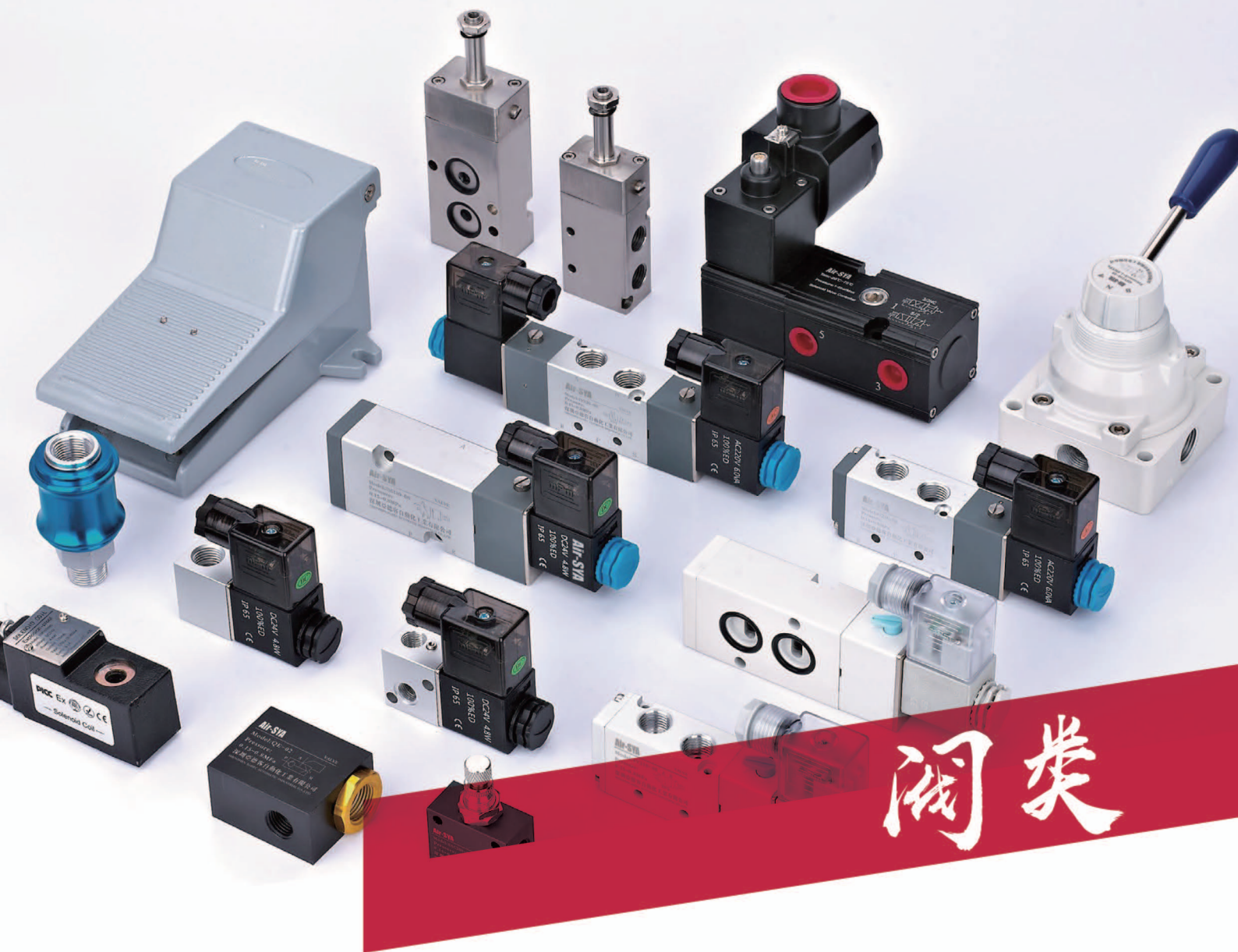

## 控制元件

SMC 型、亚德客型、费斯托型、CKD 型、电磁阀  
 机械阀、手拉阀、手扳阀、手滑阀、手转阀、脚踏阀  
 水阀、蒸汽阀、脉冲阀、老阀、线圈、防爆线圈等



**金角獸**  
 JIN JIAO SHOU  
 ☎ 4008-270-668

# CONTENTS

## 目录

				
13 4V 系列电磁阀	13 2V/3V 系列电磁阀	13 4M 系列电磁阀	13 4H 系列手扳阀	13 4A 系列气控阀
				
14 3R/4R 系列手拉阀	14 2V 系列 (空压机专用)	14 VF/DS 系列电磁阀	14 金属型 MVSC 电磁阀	14 海隆系列电磁阀
	SMC 型 			
14 VP 系列电磁阀	14 VT 系列电磁阀	15 Q 锡类肇庆型电磁阀	15 551 电磁阀	15 手转阀
				
15 脚踏阀	15 S3 系列机械阀	16 M5/M3 系列机械阀	16 JM 系列机械阀	16 CM3 系列机械阀
				
16 VM131 系列机械阀	17 MOV 系列机械阀	17 VM 系列机械阀	17 JMJ 系列机械阀	17 MV322/MV522 系列机械阀
				
17 新益型机械阀	17 梭阀	18 手滑阀	18 流量控制阀	18 先导式电磁阀系列

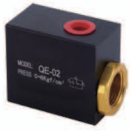

18 快速排气阀



18 单向阀



18 济南华能 K 系列换向阀



18 KQ 系列单控换向阀



19 KQ 系列换向阀



19 KQ 系列双控换向阀



19 KQ 系列三位五通双控



19 KQ 系列截止阀



19 无锡型 W 阀



19 ASCO 型直角脉冲阀



20 高原系列脉冲阀



20 上海袋式系列脉冲阀



20 脉冲阀控制仪



21 2W 全铜水阀



21 2S 系列不锈钢电磁阀



21 气控阀

亚德客型



21 直动式两通阀

宝德型



21 高压两通阀耐高温

宝德型



21 两通阀



21 KSD 型电磁阀



21 蒸汽电磁阀

新恭型



21 黄铜两通阀 直动式

新恭型



21 黄铜两通阀 先导式

SMC 型



21 铜两通阀 常闭式直动



21 Q22 系列气控阀



22 角座阀



22 膜片维修包 ASCO 型



22 汇流板



22 4V2 防爆线圈



22 线圈类



**金角獸**  
JIN JIAO SHOU  
☎ 4008-270-668

# SOLENOID VALVE EXPLOSION DIAGRAM

气源处理件结构爆炸图

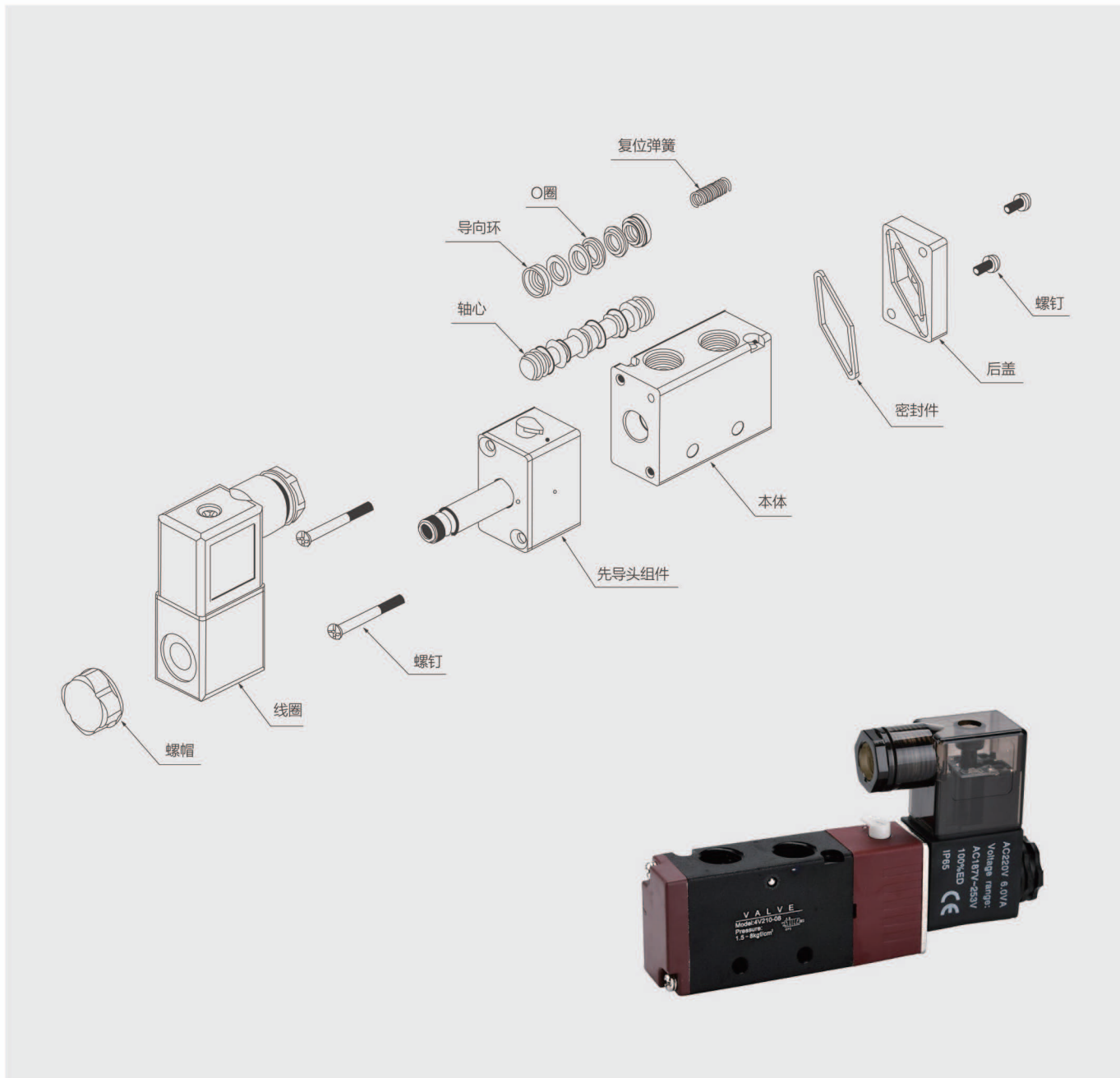

让气动采购更简单

4V 系列电磁阀	型号	精品	经济
	4V110-06	42.00	34.00
	4V120-06	64.00	56.00
	4V130-06C	104.00	78.00
	4V210-08	33.00	31.00
	4V210-08 (红黑)	-	35.00
	4V220-08	62.00	54.00
	4V230-08C	82.00	76.00
	4V310-08	49.00	42.00
	4V310-10	44.00	42.00
	4V310-10 (红黑)	-	46.00
	4V320-10	64.00	67.00
	4V330-10C	97.00	89.00
	4V410-15	75.00	67.00
	4V420-15	110.00	100.00
	4V430-15C	141.00	130.00
HH			
HF			

2V/3V 系列电磁阀	型号	精品	经济
	2V025-08	30.00	29.00
	3V1-06	32.84	29.00
	3V110-06	42.00	-
	3V120-06	64.00	-
	3V130-06	104.00	-
	3V210-08	33.00	34.00
	3V220-08	55.00	-
	3V230-08	75.00	-
	3V310-10	46.00	45.00
	3V320-10	64.00	-
	3V330-10	97.00	-
	3V410-15	77.00	76.00
	3V420-15	97.00	-
	3V430-15	141.00	-
	HH		
HF			

注：C 中央封闭型，E 中央排气型，P 中央压力型，三款价格一样。

4M 亚德客型电磁阀	型号	精品	经济
	4M210-08	34.00	33.00
	4M210-08 (红黑)	-	35.00
	4M210-08-L	-	35.00
	4M310-08	45.00	42.00
	4M310-08 (红黑)	-	44.00
	4M410-15	76.00	76.00
HH			
HF			

4H 系列手扳阀	型号	精品	经济
	4H210-08	31.00	26.00
	4H310-10	42.00	38.00
	4H410-15	75.00	74.00
HH			
HF			

4A 系列气控阀	型号	精品	经济
	4A310-10	38.00	33.00
	4A320-10	51.00	-
	4A330-10	68.00	-
	4A410-15	60.00	57.00
	4A420-15	70.00	-
	4A430-15	97.00	-
HH			
HF			

4A 系列气控阀	型号	精品	经济
	4A110-06	33.00	-
	4A120-06	42.00	-
	4A130-06	60.00	-
	4A210-08	29.00	27.00
	4A220-08	38.00	-
	4A230-08	60.00	-
HH			
HF			

3R/4R 系列手拉阀	型号	精品	经济	
	4R210-08	31.00	24.00	
	4R310-10	42.00	34.00	
	4R410-15	74.00	65.00	
	3R210-08	31.00	26.00	
	3R310-10	42.00	35.00	
	3R410-15	74.00	-	
	HH			
	HF			

2V 系列 (空压机专用)	型号	单价
	2V025-06 型材 接线壳线圈	18.66
	2v025-08 接线壳线圈	21.62
	2V025-06 压铸 接线壳线圈	17.60
	2V025-06 型材 引线	17.60
	2V025-06 压铸 引线	16.54
	2v025-06 圆 引线	13.78
HA		

VF/DS 系列电磁阀	型号	精品	经济
	VF3130/DS3130	77.0	61.34
	VF3230/DS3230	-	94.18
	VF3330/DS3330(中封)	-	179.28
	VF3430/DS3430(中泄)	-	179.28
	VF3530/DS3530(中压)	-	179.28
	VF5120/DS5120	110	84.02
	VF5220/DS5220	-	116.64
	VF5320/DS5320(中封)	-	216.00
	VF5420/DS5420(中泄)	-	216.00
	HC HB	VF5520/DS5520(中压)	-

金器型 MVSC 电磁阀	型号	单价
	MVSC180-4E1 (单电控)	66.50
	MVSC220-4E1 (单电控)	53.20
	MVSC220-4E2 (双电控)	85.50
	MVSC260-4E1 (单电控)	60.80
	MVSC260-4E2 (双电控)	91.20
	MVSC300-4E1 (单电控)	85.50
	MVSC300-4E2 (双电控)	123.50
	MVSC460-4E1 (单电控)	104.50
	MVSC460-4E2 (双电控)	152.00
	HC	

VP 系列电磁阀	型号	单价
	VP342/DS342	112.32
	VP542/DS542	142.56
	VP342R(外部先导)	120.96
	VP542R(外部先导)	153.36
HB		

海隆系列电磁阀	型号	单价
	2636000	67.84
	2636000B	67.84
	2637050	95.40
	2637050B	95.40
	8020750	65.72
	8020850	84.80
	2636200	116.60
	2637250	137.80
	HA	

SMC 型 VT 系列电磁阀	型号	单价
	VT307-3G1-01	70.00
	VT307-4G1-01	70.00
	VT307-5G1-01	70.00
	VT307-6G1-01	70.00
	VT307-3G1-02	70.00
	VT307-4G1-02	70.00
	VT307-5G1-02	70.00
	HL	VT307-6G1-02

Q 系列肇庆型电磁阀	型号	单价
	Q25DC-20	307.40
	Q25DC-25	307.40
	Q25D2C-20	392.20
	Q25D2C-25	392.20
	Q35D2C-20	508.80
	Q35D2C-25	508.80

HA

551 电磁阀	型号	单价
	M551-A001	130.00
	M551-A002	170.00

HB

手转阀	型号	单价
	4HV210-08/06	41.80
	4HV310-10/08	48.40
	4HV410-15/20	121.00
	4HV230-08/06	41.80
	4HV330-10/08	48.40
	4HV430-15/20	121.00
	HV200B/D	31.90
	HV-02/03/04	33.00
	HV400-02/03/04 (大手柄)	37.40

YM

脚踏阀	型号	单价
	FV320	37.40
	FV420	41.80
	3F/4F210-08	46.20
	4F210-08L	52.80
	4F210-08G	66.00
	4F210-08LG	74.80

YM

S3 系列机械阀	型号	老款	新款
	S3B-M5	26.24	/
	S3B-06	27.22	/
	S3B-08	29.16	/
	S3R-M5	32.08	34.02
	S3R-06	33.04	35.00
	S3R-08	35.00	36.94
	S3L-M5	33.04	35.00
	S3L-06	34.02	35.96
	S3L-08	35.96	37.90
	S3HL-M5	30.14	/
	S3HL-06	31.10	/
	S3HL-08	33.04	/
	S3Y-M5	/	36.94
	S3Y-06	/	37.90
	S3Y-08	/	39.86
	S3C-M5	/	36.94
	S3C-06	/	37.90
	S3C-08	/	39.86
	S3D-M5	/	35.96
	S3D-06	/	36.94
	S3D-08	/	38.88
	S3PL-M5	37.90	37.90
	S3PL-06	38.88	38.88
	S3PL-08	40.82	40.82
	S3PP-M5-G/R/B	36.94	36.94
	S3PP-06-G/R/B	37.90	37.90
	S3PP-08-G/R/B	39.86	39.86
	S3PM-M5-G/R/B	36.94	36.94
	S3PM-06-G/R/B	37.90	37.90
	S3PM-08-G/R/B	39.86	39.86
	S3PF-M5-G/R/B	36.94	36.94
	S3PF-06-G/R/B	37.90	37.90
	S3PF-08-G/R/B	39.86	39.86
	S3HS-M5	37.90	37.90
	S3HS-06	38.88	38.88
	S3HS-08	40.82	40.82
	S3V-M5	32.08	/
	S3V-06	33.04	/
	S3V-08	35.00	/

HB



M5/M3 系列机械阀	型号	单价
	M5B110/M3B110-06	30.72
	M5C110/M3C110-06	42.76
	M5D110/M3D110-06	40.82
	M5R110/M3R110-06	40.82
	M5L110/M3L110-06	42.76
	M5Y110/M3Y110-06	42.76
	M5PM110/M3PM110-06	42.76
	M5PP110/M3PP110-06	42.76
	M5PF110/M3PF110-06	42.76
	M5PL110/M3PL110-06	44.72
	M5HS110/M3HS110-06	44.72
	M5B210/M3B210-08/06	31.40
	M5C210/M3C210-08/06	42.76
	M5D210/M3D210-08/06	40.82
	M5R210/M3R210-08/06	40.82
	M5L210/M3L210-08/06	42.76
	M5Y210/M3Y210-08/06	42.76
	M5PM210/M3PM210-08/06	42.76
	M5PP210/M3PP210-08/06	42.76
	M5PF210/M3PF210-08/06	42.76
	M5PL210/M3PL210-08/06	44.72
	M5HS210/M3HS210-08/06	44.72

JM322 系列机械阀	型号	单价
	JM322	24.50
	JM322R(JM-07)	27.80
	JM322PP	27.80
	JM322PPL	27.80
	JM322PB(JM-06A)	27.80
	JM322EB(JM-06)	28.78
	JM322TB (JM-05)	28.78
	JM322LB	28.78

CM3 系列机械阀	型号	单价
	CM3B	14.58
	CM3R	17.50
	CM3L	20.42
	CM3PL	21.38
	CM3PF	20.42
	CM3PP	20.42
	CM3PM	20.42
	CM3HS	21.38
	CM3V-06	36.94
	CM3Y-06	38.88

VM131 系列机械阀	型号	单价
	VM131-01-00	16.52
	VM131-01-01	20.42
	VM131-01-02	24.30
	VM131-01-37	25.28
	VM131-01-30	24.30
	VM131-01-32	24.30
	VM131-02-33	24.30
	VM131-03-34	25.28
	VM131-01-05	38.88
	VM131-01-06	40.82
	VM131-01-08	42.76

MOV321 系列机械阀	型号	单价
	MOV321	14.58
	MOV321R (MOV-02)	17.50
	MOV321PP	17.50
	MOV321PPL	17.50
	MOV321PB(MOV-03A)	17.50
	MOV321EB(MOV-03)	18.46
	MOV321TB(MOV-01)	18.46
	MOV321LB	18.46
HB		

VM230 系列机械阀	型号	单价
	VM230-02-00	35.00
	VM230-02-01	38.88
	VM230-02-37	41.80
	VM230-02-30	40.82
	VM230-02-32	40.82
	VM230-02-33	40.82
	VM230-02-34	41.80
HB		

JMJ 系列机械阀	型号	单价
	JMJ-00	30.72
	JMJ-07	33.82
	JMJ-05	33.82
	JMJ-06	33.82
	JMJ-04	33.82
	JMJ-03	34.80
	JMJ-01	34.80
	JMJ-02	34.80
HB		

MV322/MV522 系列机械阀	型号	单价	
	MV322/MV522	30.72	
	MV322/MV522R	33.82	
	MV322/MV522PP	33.82	
	MV322/MV522PPL	33.82	
	MV322/MV522PB	33.82	
	MV322/MV522EB	34.80	
	MV322/MV522TB	34.80	
	MV322/MV522LB	34.80	
HB			

新益型机械阀	型号	单价
	XQ250610/XQ230610	38.88
	XQ250612/XQ230612	50.54
	XQ250622/XQ230622	42.76
	XQ250410/XQ230410	38.88
	XQ250412/XQ230412	50.54
	XQ250422/XQ230422	42.76
HB		

梭阀	型号	单价
	ST-01	13.22
	ST-02	14.38
	ST-03	22.56
	ST-04	24.50
HB		

手滑阀	型号	单价
	HSV-06-B/SF/FF/SS	11.00
	HSV-08-B/SF/FF/SS	12.10
	HSV-10-B/SF/FF/SS	16.50
	HSV-15-B/SF/FF/SS	19.80
	HSV-15-B/SF/FF/SS(大体)	30.80

YW

流量控制阀	型号	单价
	RE-01/02	9.90
	RE-03/04	13.20
	ASC-06	11.00
	ASC-08	12.10
	ASC-10	14.30
	ASC-15	16.50

YW

先导电磁阀系列	型号	单价
	Q22XD-2L 铝	41.34
	Q23XD-2L 铝	41.34
	Q23XD-2L 铜	50.88
	Q22XD-2L 铜	50.88

HA

快速排气阀	型号	单价
	QE-01	8.80
	QE-02	8.80
	QE-03	8.80
	QE-04	8.80

YM

单向阀	型号	单价
	KA-06/08	15.40
	KA-10/15	24.20
	KA-20	46.20
	KA-25	50.60
	KA-32/40	220.00
	KA-50	242.00

YW

济南华能 K 系列换向阀	型号	单价
 K25DH-15J	K25DH-8-J AC220V	108.12
	K25DH-8-J DC24V	108.12
	K25DH-10-J AC220V	137.80
	K25DH-10-J DC24V	137.80
	K25DH-15-J AC220V	137.80
	K25DH-15-J DC24V	137.80
	K25DH-20-J AC220V	318.00
	K25DH-20-J DC24V	318.00
	K25DH-25-J AC220V	318.00
	K25DH-25-J DC24V	318.00
	K25D2H-8-J AC220V	150.52
	K25D2H-8-J DC24V	150.52
	K25D2H-10-J AC220V	169.60
	K25D2H-10-J DC24V	169.60
	K25D2H-15-J AC220V	169.60
	K25D2H-15-J DC24V	169.60
	K25D2H-20-J AC220V	413.40
	K25D2H-20-J DC24V	413.40
	K25D2H-25-J AC220V	413.40
	K25D2H-25-J DC24V	413.40

HA

KQ 系列换向阀	型号	单价
	Q24DH-8	91.16
	Q24DH-10	116.60
	Q24DH-15	116.60
	Q24D2H-8	127.20
	Q24D2H-10	148.40
	Q24D2H-15	148.40

HA

KQ 系列单控换向阀	型号	单价
	K25DH-8	91.16
	K25DH-10	116.60
	K25DH-15	116.60
	K25DH-20	318.00
	K25DH-25	318.00
	K25DH-50	2226.00

HA

KQ 系列双控换向阀	型号	单价
	K25D2H-8	127.20
	K25D2H-10	148.40
	K25D2H-15	148.40
	K25D2H-20	413.40
	K25D2H-25	413.40
	K25D2H-40	1738.40

HA

KQ 系列三位五通双控	型号	单价
	K35D2H-8	190.80
	K35D2H-10	222.60
	K35D2H-15	222.60
	K35D2H-20	508.80
	K35D2H-25	508.80
	K35D2H-40	2713.60

HA

KQ 系列截止阀	型号	单价
	K23JD-8	80.56
	K23JD-15	89.04
	K23JD-20	222.60
	K23JD-25	222.60
	K23JD-25W	243.80
	K25JD-8	122.96
	K25JD-10	180.20
K25JD-15	180.20	

HA

无锡型 W 阀	型号	单价
	K23JD-8-10-15W	264.00
	K23JD-20-25W	356.40
	K23JD-32-40W	646.80
	K23JD-50W	792.00
	K22JD-8-10-15W	264.00
	K22JD-20-25W	330.00
	K22JD-32-40W	607.20
	K22JD-50W	752.40
	K22JK-8-10-15W	149.60
	K22JK-20-25W	215.60
	K22JK-32-40W	451.00
	K22JK-50W	580.80
	K23JK-8-10-15W	158.40
	K23JK-20-25W	620.40
	K23JK-32-40W	475.20
	K23JK-50W	231.00
	K25JD-8-10-15W	319.00
	K25JD-20-25W	479.60
	K25JD-40W	1003.20
	K25JK-8-10-15W	215.60
	K25JK-20-25W	369.60
	K25JK-40W	897.60
	DF3-20-20W	871.20
	DF4-20-25W	1091.20
K23JSD-L15	1584.00	
K23JSD-L20-25	1716.00	
K23JSD-L32-40	4224.00	
K23DA-4W	158.40	

HA

ASCO 直角脉冲阀	型号	单价
	AMF-Z-20(直角式)	106.00
	AMF-Z-25(直角式)	106.00
	AMF-Z-40S(直角式)	212.00
	AMF-Z-50S(直角式)	333.90
	AMF-Z-62S(直角式)	324.36
	AMF-Z-76S(直角式)	398.56

HA

高原系列脉冲阀	型号	单价
	TMF-Z-20(直角式)	41.34
	TMF-Z-25(直角式)	41.34
	TMF-Z-32S(直角式)	110.24
	TMF-Z-40S(直角式)	110.24
	TMF-Z-50S(直角式)	212.00
	TMF-Z-62S(直角式)	243.80
	TMF-Z-76S(直角式)	286.20
	TMF-Z-20A(直角式)	84.80
	TMF-Z-20P(直角式)	80.56
	TMF-Z-25P(直角式)	80.56
	TMF-Z-25DD(直角式)	159.00
	TMF-Z-45DD(直角式)	201.40
	TMF-Y-50S(淹没式)	201.40
	TMF-Y-62S(淹没式)	222.60
	TMF-Y-76S(淹没式)	233.20

HA

上海袋式系列脉冲阀	型号	单价
	DMF-Z-20(直角式)	80.56
	DMF-Z-25(直角式)	80.56
	DMF-Z-40S(直角式)	116.60
	DMF-Z-50S(直角式)	233.20
	DMF-Z-62S(直角式)	265.00
	DMF-Z-76S(直角式)	296.80
	DMF-Z-25DD(直角式)	159.00
	DMF-Z-45DD(直角式)	201.40
	DMF-Y-50S(淹没式)	212.00
	DMF-Y-62S(淹没式)	243.80
DMF-Y-76S(淹没式)	254.40	

HA

脉冲阀控制仪	型号	单价
	6路	136.00
	8路	136.00
	10路	156.00
	12路	156.00

ZZ

2W 常闭水阀	型号	精品	经济
	2W025-08	35.86	29.70
	2W040-10	61.44	47.30
	2W160-15	-	61.60
	2W200-20	-	66.00
	2W250-25	-	99.00
	2W350-35		209.00
	2W400-40	-	217.80
	2W500-50	-	319.00
	2W160-15(连体)	68.20	-
	2W200-20(连体)	77.34	-
	2W250-25(连体)	110.72	-
	2W350-35(小体)	154.00	-
	2W400-40(小体)	264.00	-
	2W500-50(小体)	323.96	-

HR

2W 常开水阀	型号	单价
	2W025-08NO	81.40
	2W040-10NO	99.00
	2W160-15NO	118.80
	2W200-20NO	127.60
	2W250-25NO	156.20
	2W350-35NO(小体)	193.60
	2W400-40NO(小体)	347.60
	2W500-50NO(小体)	413.60

HR

2S 系列不锈钢常闭流体电磁阀	型号	单价
	2S025-08	73.16
	2S040-10	99.00
	2S160-15	100.32
	2S200-20	112.86
	2S250-25	167.20
	2S350-35	355.30
	2S400-40	355.30
	2S500-50	501.60

HR

气控阀	型号	单价
	2Q160-10	210.00
	2Q160-15	210.00
	2Q200-20	232.00
	2Q250-25	316.00

HE

亚德客型铜两通阀	型号	单价
	2V025-06	40.00
	2V025-08	40.00
	2V130-10	120.00
	2V130-15	120.00
	2V250-20	228.00
	2V250-25	228.00

HE

宝德型 高压两通阀 耐高温 150度	型号	单价
	5404-02D	204.00
	5404-04D	204.00
	5404-06D	350.00
	5404-08D	350.00

HE

宝德型 两通阀	型号	单价
	6213-02	94.00
	6213-04	110.00
	6213-06	142.00
	6213-08	218.00

HE

KSD 型电磁阀	型号	单价
	DC231Y-08	76.00
	FB2E-V	66.00

DC231Y-08

HE

蒸汽电磁阀	型号	单价
	US-15	209.00
	US-20	231.00
	US-25	266.20
	US-35	363.00
	US-40	363.00
	US-50	583.00

HR

新恭型 黄铜两通阀 直动式	型号	单价
	PU220-01AR	40.00
	PU220-02AR	40.00
	PU220-03AR	110.00
	PU220-04AR	110.00
	PU220-03A	140.00
	PU220-04A	140.00
	PU220-06A	150.00
	PU220-08A	206.00

HE

新恭型 黄铜两通阀 先导式	型号	单价
	PU225-03A	140.00
	PU225-04A	140.00
	PU225-06A	150.00
	PU225-08A	204.00
	PU225-12A	366.00
	PU225-14A	366.00
	PU225-20A	630.00

HE

SMC 型 铜两通阀 常闭式直动	型号	单价
	VX2120-06	62.00
	VX2120-08	62.00
	VX2120-10	102.00
	VX2120-15	152.00

HE

Q22 系列气控阀	型号	单价
	Q22HD-15	88.00
	Q22HD-20	103.40
	Q22HD-25	125.40
	Q22HD-32	242.00
	Q22HD-40	275.00
	Q22HD-50	308.00

AY

气动丝扣角座阀	型号	塑料头	全钢头
	DN15	80.96	137.64
	DN20	101.20	157.88
	DN25	121.44	178.12
	DN25 (大头)	158.40	237.60
	DN32	207.90	287.10
	DN40	227.70	306.90
	DN50	297.00	376.20
	DN50 (大头)	346.50	514.80
	HJ	DN65	554.40

脉冲阀膜片维修包	型号	单价
	A20/25	14.30
	A40	44.00
	A50/62	63.80
	A76	92.40
	A3.5 寸	114.40
	G15P/20P/25P	22.00
	G35P	31.90
	G45P	46.20
	G50Y	56.10
	G62Z	60.50
	G76Y	64.90
	G3.5 寸	99.00
	10	22.00
	11	24.20
	20	44.00
	24.5	53.90
	29.5	64.90
31.5	69.30	
HA	45	99.00

汇流板	型号	单价
	4V100	3.52/ 位
	4V200	3.18 / 位
	4V300	6.82 / 位
	4V400	13.64 / 位
	3V100M	4.18 / 位
	3V200M	4.40 / 位
	3V300M	7.92 / 位
	SY3120	6.60 / 位
	SY5120	6.60 / 位
	WE	SY7120

线圈类	型号	单价
	4V210(带灯)	9.00
	4V210(引线)	9.00
	4V110(带灯)	9.00
	4V110(引线)	7.00
	CY123	18.00
	A044	28.00
	A051	34.00
	DMF(热塑)	18.00
	0200	15.00
	0545	31.00
	宝德(热塑)	30.00
	HB700	22.00
	13383	31.00
	1030	11.00
	11402	22.00
	K-2	19.80
	K-3	39.60
	J001	30.00
	1321	180.00
	1421	202.00
	1621	202.00
	110 引线	7.00
	AB310	20.00
	AB410	30.00
	AB510	40.00
	BD-RG	20.00
	DMF-RG	34.00
	HB600	18.00
	NASCO	68.00
	0543	20.00
FJ	TEB	22.00

防爆线圈	型号	单价
	XQ-EX01 (4V 适用)	84.00
	XQ-EX02 (4V 适用)	84.00

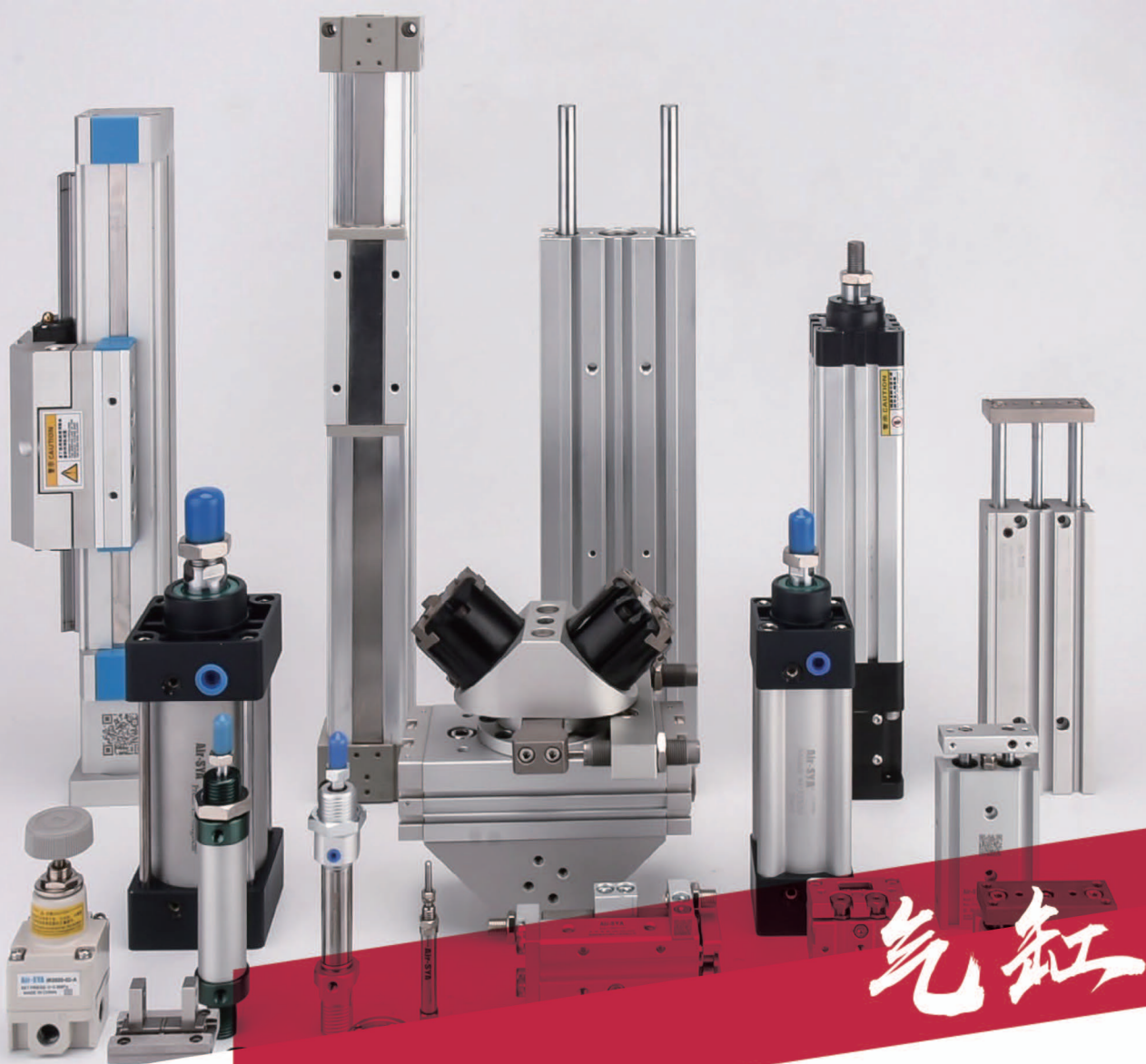

## 执行元件

费斯托型、SMC 型、亚德客型

标准缸、薄型缸、迷你缸、双轴缸、无杆缸、气动手指

旋转缸、滑台缸、针型缸、增压缸、空压冲床

各类进口替代非标气缸等



# 金角獸

JIN JIAO SHOU

☎ 4008-270-668



# CONTENTS

## 目录



# 金角獸

JIN JIAO SHOU

☎ 4008-270-668



27 SC 系列标准气缸



28 SDA 系列薄型气缸



29 CQ2B 系列薄型气缸



29 MGPL-Z/TCL-S 系列  
薄型带导杆气缸



30 MGPM/TCM 系列  
薄型带导杆气缸



30 TN(TDA)系列双轴气缸



31 QGB 系列气缸



32 CDM2B 不锈钢迷你气缸



32 MA 不锈钢迷你气缸



32 MAL 铝合金迷你气缸



33 CDJ2B (PB) 系列  
不锈钢迷你气缸



33 CJPB 单动系列



33 CDJPB/CDJP2B



33 CDJPT/CDJP2T



34 CJ1B 系列针型气缸



34 CDUJB 小型自由安装气缸



34 CRA1/CDRA1 系列摆动气缸  
(齿轮齿条式)



34 MSQB (HRQ) 系列摆动气缸  
(齿轮齿条式)



35 CRQ2B/CDRQ2B 系列  
薄型摆动气缸 (齿轮齿条式)



35 MK 系列回转夹紧气缸



35 QCK



35 气动手指系列



35 MHL2 系列电磁阀气动手指



36 MHT2 气爪系列



36 MHF2 系列薄型气爪



36 MHW2 系列气爪



36 HDM 系列角度型机械爪



37 MHS 系列气爪



37 夹紧气缸



37 无杆气缸



40 气动执行器



41 ADN 薄型缸系列



42 CQ2A 超长行程  
薄型气缸系列



42 ADVU 薄型缸系列



43 CA2 铝合金标准气缸系列



44 MBB-Z 铝合金标准气缸系列



45 DNC(SE)系列 15552  
标准气缸系列



46 MGJ 系列  
微型带导杆气缸



46 CDU 自由安装气缸



46 滑台气缸



47 增压缸



48 压力机



49 气缸附件



51 DBF 刹车气缸



51 TXJ 系列夹具



51 ALC/JGL 系列杠杆气缸



51 ACKL/ACKR 转角夹紧气缸



51 SRCL/SRCR 转角下压气缸

精品



52 精品型 SC 气缸

精品



53 平行手指

精品



53 宽型手指

精品



53 支点手指

精品



53 摆动气缸



**金角獸**  
JIN JIAO SHOU  
☎ 4008-270-668

# SC TYPE STANDARD CYLINDER EXPLOSION DIAGRAM

SC 型标准气缸结构爆炸图



让气动采购更简单

SC 标准气缸	行程	缸径									
		32	40	50	63	80	100	125	160	200	250
	25	31.88	38.96	46.06	56.68	85.02	108.04	194.84	389.66	667.16	1334.30
	50	35.42	42.50	49.60	60.22	90.34	115.12	203.68	407.38	685.68	1371.36
	75	38.96	44.28	53.14	63.76	95.64	122.22	212.54	425.08	704.22	1408.44
	100	40.74	47.82	56.68	67.30	100.96	127.52	221.40	442.80	722.74	1445.50
	125	42.50	49.60	60.22	70.84	106.28	132.84	230.26	460.52	741.28	1482.56
	150	44.28	51.36	62.00	74.40	111.58	138.16	239.12	478.22	778.34	1519.62
	175	46.06	54.90	65.54	77.94	116.90	145.24	247.96	495.94	796.88	1556.68
	200	47.82	56.68	67.30	81.48	122.22	150.56	256.82	513.64	815.40	1593.76
	250	51.36	62.00	74.40	88.56	132.84	164.72	274.54	549.08	852.48	1667.88
	300	54.90	67.30	81.48	97.42	143.46	173.58	292.24	584.50	889.54	1742.00
	350	58.44	72.62	86.78	106.28	154.10	187.74	309.96	619.92	945.14	1797.60
	400	62.00	77.94	93.88	113.36	164.72	200.14	327.68	655.34	982.20	1853.20
	450	67.30	83.24	99.18	120.44	175.34	212.54	345.38	690.76	1037.80	1908.80
	500	72.62	88.56	106.28	127.52	185.98	224.94	363.10	726.20	1074.86	1964.40
	550	77.94	93.88	111.58	134.62	194.84	237.34	389.66	761.62	1130.46	2038.52
	600	81.48	99.18	118.68	141.70	205.46	251.52	407.38	797.04	1167.52	2094.12
	650	86.78	104.50	125.76	148.78	216.08	262.14	425.08	814.76	1204.58	2149.72
	700	90.34	109.82	132.84	155.86	226.72	272.76	442.80	850.18	1260.18	2223.84
	750	95.64	115.12	138.16	162.96	235.56	283.40	460.52	885.60	1297.24	2297.96
	800	99.18	120.44	143.46	170.04	244.42	295.80	478.22	921.02	1334.30	2353.56
	850	104.50	125.76	148.78	177.12	251.52	306.42	495.94	956.44	1389.90	2409.16
	900	108.04	131.06	155.86	185.98	262.14	318.82	513.64	991.88	1445.50	2483.28
	950	113.36	136.38	161.18	194.84	272.76	329.44	531.36	1027.30	1482.56	2538.88
	1000	116.90	141.70	168.26	200.14	283.40	341.84	549.08	1062.72	1519.62	2594.48
	+100 行程	10.62	12.40	14.16	17.72	21.26	26.56	38.96	70.84	111.20	148.26
	带磁 -S	3.54	3.54	5.32	5.32	7.08	8.86	14.16	21.26	37.06	55.60
	AA 耐高温 -H	35.42	38.96	47.82	56.68	70.84	79.70	132.84	221.40	407.70	704.22



注：SCD 双出价格加 30%，SCJ 可调 50MM 行程以内 40%，可调 100MM 内加 50%。

### SC 密封圈

型号	缸径									
	32	40	50	63	80	100	125	160	200	250
SC 密封圈	5.50	6.60	7.70	8.80	11.00	13.20	28.60	35.20	79.20	132.00

SDA 系列薄型气缸	行程	缸径									
		12	16	20	25	32	40	50	63	80	100
	5	13.48	13.48	15.16	16.84	21.90	26.96	38.76	50.54	84.24	128.04
	10	15.16	15.16	16.84	18.54	23.58	28.64	40.44	53.92	87.60	134.78
	15	16.84	16.84	16.84	20.22	25.28	30.32	43.80	55.60	90.98	139.84
	20	16.84	16.84	18.54	20.22	26.96	32.02	45.48	58.96	94.34	144.90
	25	18.54	18.54	18.54	21.90	28.64	33.70	47.18	60.66	97.72	151.64
	30	18.54	18.54	20.22	23.58	28.64	35.38	48.86	62.34	101.08	156.68
	35	20.22	20.22	20.22	25.28	30.32	37.06	50.54	64.02	104.46	161.74
	40	20.22	20.22	21.90	25.28	32.02	38.76	52.22	67.40	107.82	166.80
	45	21.90	21.90	23.58	26.96	33.70	40.44	53.92	69.08	111.20	171.84
	50	21.90	21.90	25.28	28.64	33.70	42.12	55.60	72.44	114.56	176.90
	55	23.58	23.58	25.28	28.64	35.38	43.80	58.96	75.82	117.94	181.96
	60	23.58	23.58	26.96	30.32	37.06	45.48	60.66	77.50	121.30	187.02
	65	25.28	25.28	26.96	32.02	37.06	47.18	62.34	80.88	124.68	192.06
	70	25.28	25.28	28.64	32.02	38.76	48.86	65.70	84.24	128.04	197.12
	75	26.96	26.96	30.32	33.70	40.44	50.54	67.40	87.60	131.42	202.18
	80	26.96	26.96	30.32	33.70	40.44	52.22	69.08	89.30	134.78	207.24
	85	28.64	28.64	32.02	35.38	42.12	53.92	70.76	92.66	138.16	212.28
	90	28.64	28.64	32.02	35.38	43.80	55.60	72.44	94.34	141.52	219.02
	95	30.32	30.32	33.70	37.06	45.48	57.28	74.14	97.72	144.90	224.08
	100	30.32	30.32	33.70	37.06	47.18	58.96	75.82	101.08	148.26	229.14
	+10 行程	3.36	3.36	5.06	6.74	6.74	6.74	8.42	8.42	13.48	16.84
	带磁 -S	5.06	5.06	5.06	8.42	8.42	13.48	16.84	16.84	25.28	30.32
	外牙 -B	3.36	3.36	3.36	3.36	3.36	3.36	5.06	5.06	8.42	8.42
	耐高温 -H	15.16	15.16	16.84	20.22	25.28	30.32	33.70	42.12	67.40	92.66



注：SDAD\*1.4, SDAJ 可调行程 50MM 内 \*1.4, 可调行程 100MM 内 \*1.5, 单作用 \*1.5。

CQ2B 系列薄型气缸	行程	缸径										
		12	16	20	25	32	40	50	63	80	100	125
	5	28.06	28.06	28.06	29.92	33.66	39.28	52.36	71.06	129.04	179.52	504.90
	10	29.92	29.92	29.92	29.92	33.66	41.14	54.24	74.80	132.78	185.14	523.60
	15	29.92	29.92	29.92	31.80	35.54	43.02	56.10	76.68	136.52	188.88	542.30
	20	31.80	31.80	31.80	31.80	35.54	44.88	57.98	80.42	140.26	194.48	561.00
	25	31.80	31.80	31.80	33.66	37.40	46.76	59.84	82.28	144.00	198.22	579.70
	30	33.66	33.66	33.66	33.66	37.40	48.62	61.72	86.02	147.74	203.84	598.40
	35	33.66	33.66	33.66	35.54	39.28	50.50	63.58	87.90	151.48	207.58	617.10
	40	35.54	35.54	35.54	37.40	39.28	52.36	65.46	91.64	155.22	213.18	635.80
	45	37.40	37.40	37.40	37.40	41.14	54.24	67.32	93.50	158.96	216.92	654.50
	50	37.40	37.40	37.40	39.28	43.02	56.10	69.20	97.24	162.70	222.54	673.20
	60	-	-	39.28	41.14	44.88	59.84	74.80	102.86	170.18	231.88	729.30
	75	-	-	43.02	43.02	46.76	65.46	84.16	110.34	181.40	244.98	785.40
	100	-	-	46.76	48.62	54.24	74.80	97.24	125.30	200.10	269.28	935.00
	带 D	11.22	11.22	11.22	11.22	11.22	14.96	18.70	26.18	37.40	46.76	56.10
AA	外牙 -DM	3.74	3.74	3.74	3.74	3.74	3.74	5.62	5.62	9.36	9.36	9.36



注：双出 \*1.4，可调行程 50mm 内 \*1.4，可调行程 100mm 内 \*1.5，单作用 \*1.5。

MGPL-Z/TCL-S 系列薄型带导杆气缸	行程	缸径										
		12	16	20	25	32	40	50	63	80	100	
	10	150.48	166.32	-	-	-	-	-	-	-	-	-
	20	155.24	171.08	188.50	210.68	-	-	-	-	-	-	-
	25	-	-	-	-	262.94	293.04	369.08	467.28	899.72	1386.00	-
	30	158.40	174.24	194.84	215.42	-	-	-	-	-	-	-
	40	164.74	180.58	204.34	226.52	-	-	-	-	-	-	-
	50	171.08	186.92	213.84	236.02	293.04	332.64	408.68	516.38	958.32	1465.20	-
	75	180.58	196.42	229.68	266.12	323.14	362.74	448.28	567.08	1137.32	1672.70	-
	100	190.08	205.92	245.52	294.62	353.24	392.84	487.88	606.68	1235.52	1851.70	-
	125	210.68	228.10	269.28	324.72	392.84	421.34	527.48	646.28	1393.92	2089.30	-
	150	229.68	258.20	297.80	364.32	432.44	460.94	586.08	695.38	1533.32	2187.50	-
	175	250.28	297.80	326.30	413.42	472.04	500.54	646.28	765.08	1720.22	2494.80	-
	200	269.28	326.30	365.90	453.02	511.64	560.74	685.88	844.28	1810.52	2781.50	-
	250	308.88	377.00	435.60	543.32	590.84	670.04	793.58	1021.68	1987.92	3009.60	-
	300	348.48	435.60	554.40	622.52	689.04	768.24	923.48	1219.68	2146.32	3286.80	-
	350	-	-	654.20	720.72	847.44	887.04	1100.88	1417.68	2285.72	3545.00	-
	400	-	-	752.40	839.52	986.84	1045.44	1279.88	1615.68	2483.72	3762.00	-
	XC8 可调	55.44	55.44	63.36	63.36	79.20	79.20	95.04	95.04	158.40	190.08	-
AA	A 气缓冲	158.40	158.40	174.24	174.24	190.08	190.08	253.44	253.44	332.64	443.52	-



注：TCL-S 单价 ×1.1。

MGPM/TCM 系列 薄型带导杆气缸	行程	缸径									
		12	16	20	25	32	40	50	63	80	100
	10	79.20	87.12	-	-	-	-	-	-	-	-
	20	83.96	91.88	109.30	123.56	-	-	-	-	-	-
	25	-	-	-	-	167.90	198.00	258.20	356.40	693.80	1148.40
	30	87.12	95.04	115.64	128.30	-	-	-	-	-	-
	40	93.46	101.38	125.14	139.40	-	-	-	-	-	-
	50	99.80	107.72	134.64	148.90	198.00	237.60	297.80	405.50	752.40	1227.60
	75	109.30	117.22	150.48	179.00	228.10	267.70	337.40	456.20	931.40	1435.10
	100	118.80	126.72	166.32	207.50	258.20	297.80	377.00	495.80	1029.60	1614.10
	125	139.40	148.90	190.08	237.60	297.80	326.30	416.60	535.40	1188.00	1851.70
	150	158.40	179.00	218.60	277.20	337.40	365.90	475.20	584.50	1327.40	1949.90
	175	179.00	218.60	247.10	326.30	377.00	405.50	535.40	654.20	1514.30	2257.20
	200	198.00	247.10	286.70	365.90	416.60	465.70	575.00	733.40	1604.60	2543.90
	250	237.60	297.80	356.40	456.20	495.80	575.00	682.70	910.80	1782.00	2772.00
	300	277.20	356.40	475.20	535.40	594.00	673.20	812.60	1108.80	1940.40	3049.20
	350	-	-	575.00	633.60	752.40	792.00	990.00	1306.80	2079.80	3307.40
	400	-	-	673.20	752.40	891.80	950.40	1169.00	1504.80	2277.80	3524.40
	XC8 可调	55.44	55.44	63.36	63.36	79.20	79.20	95.04	95.04	158.40	190.08
AA	A 气缓冲	158.40	158.40	174.24	174.24	190.08	190.08	253.44	253.44	332.64	443.52

注：TCM 单价 ×1.1。

TN (TDA) 系列双轴气缸	行程	缸径					
		10	16	20	25	32	40
	10	32.60	37.76	46.34	60.06	99.52	240.24
	20	34.32	39.46	48.04	63.50	102.96	257.40
	30	36.04	41.18	49.76	65.20	106.40	274.56
	40	36.04	42.90	51.48	68.64	109.82	300.30
	50	37.76	44.62	53.20	72.08	113.26	322.60
	60	39.46	46.34	54.92	73.78	116.68	334.62
	70	41.18	48.04	58.34	77.22	120.12	360.36
	75	42.90	49.76	60.06	78.94	123.56	368.94
	80	42.90	51.48	61.78	80.66	126.98	377.52
	100	46.34	53.20	65.20	85.80	133.84	403.26
	125	51.48	58.34	70.36	90.94	151.00	446.16
	150	54.92	61.78	77.22	97.82	166.46	480.48
	175	60.06	66.92	85.80	108.10	180.18	600.60
	200	68.64	84.08	96.10	123.56	188.76	634.92
	250	82.36	94.38	108.10	132.14	207.64	669.24
	300	94.38	106.40	126.98	151.00	245.38	780.78
	350	-	113.26	145.86	180.18	308.88	892.32
	400	-	123.56	151.00	197.34	360.36	1003.86
	450	-	133.84	171.60	223.08	386.10	1115.40
	500	-	145.86	188.76	248.82	429.00	1338.48
AA	耐高温 -H	34.32	34.32	34.32	42.90	48.04	60.06

QGB 系列气缸	行程	缸径										
		50	63	80	100	125	160	180	200	250	320	400
	25	99.00	142.56	188.10	249.48	364.32	617.76	1267.20	931.50	1676.70	4243.50	
	50	108.90	148.50	203.94	261.36	372.24	637.56	1346.40	977.04	1687.06	4326.30	5899.50
	75	112.86	154.44	213.84	271.26	388.08	657.36	1425.60	1014.30	1728.46	4185.54	6023.70
	100	118.80	160.38	223.74	287.10	407.88	683.10	1504.80	1066.06	1769.86	4479.48	6023.70
	125	128.70	168.30	229.68	297.00	423.72	673.20	1623.60	1092.96	1800.90	4562.28	6375.60
	150	138.60	178.20	237.60	306.90	433.62	742.50	1663.20	1124.02	1867.14	4628.52	6375.60
	175	148.50	188.10	247.50	316.80	447.48	772.20	1742.40	1144.72	1925.10	4692.70	6727.50
	200	158.40	198.00	263.34	334.62	465.30	811.80	1782.00	1169.56	1987.20	4843.80	6727.50
	250	168.30	207.90	287.10	350.46	473.22	851.40	1861.20	1208.88	2088.64	4996.98	7509.96
	300	178.20	221.76	302.94	368.28	526.68	891.00	1960.20	1248.22	2250.10	5133.60	7777.00
	400	207.90	241.56	330.66	399.96	584.10	920.70	2118.60	1345.50	2442.60	5775.30	8145.46
	500	227.70	265.32	352.44	439.56	623.70	1029.60	2316.60	1449.00	2628.90	6077.52	8542.90
	600	247.50	285.12	376.20	479.16	653.40	1112.76	2514.60	1552.50	2804.86	6417.00	9076.96
	700	267.30	306.90	405.90	506.88	693.00	1168.20	2712.60	1635.30	3125.70	6727.50	9536.50
	800	287.10	328.68	445.50	534.60	716.76	1227.60	2910.60	1800.90	3249.90	7029.72	9871.84
	900	306.90	348.48	477.18	564.30	762.30	1287.00	3108.60	1925.10	3353.40	7319.52	10463.86
	1000	316.80	374.22	524.70	594.00	811.80	1405.80	3405.60	2090.70	3456.90	7907.40	10670.86



YV

注：1、缸筒颜色有黑、红、白、蓝、绿、银灰等可选，默认为蓝色；  
2、活塞杆加粗另加 35%，可调行程另加 40%，双轴另加 35%。

### QGB 系列标准气缸附件（无锡型）

型号	缸径									
	50	63	80	100	125	160	200	250	320	400
单、双耳环	39.60	39.60	49.50	53.46	63.36	118.80	196.66	496.80	1035.00	1242.00
中摆	39.60	39.60	69.30	79.20	162.36	237.60	445.06	703.80	2484.00	4347.00
法兰	35.64	35.64	55.44	69.30	83.16	118.80	196.66	496.80	1035.00	1407.60
脚架	29.70	29.70	43.56	53.46	69.30	118.80	155.26	-	-	-
Y 型接头	31.68	31.68	37.62	49.50	59.40	69.30	72.46	-	-	-
I 型接头	31.68	31.68	35.64	43.56	55.44	65.34	68.32	-	-	-
鱼眼接头	YV	-	-	-	-	158.40	165.60	-	-	-



迷你气缸

SMC 型 CDM2B 不锈钢迷你气缸	行程	缸径		
		20	25	32
	25	33.92	40.06	52.58
	50	36.46	41.76	54.28
	75	39.22	46.22	58.72
	100	41.76	50.66	62.32
	125	44.52	54.28	65.94
	150	48.12	58.72	69.54
	175	52.58	61.48	73.98
	200	56.18	65.94	78.44
	AB			

亚德客型 MA 不锈钢迷你气缸	行程	缸径				
		16	20	25	32	40
	25	25.86	33.92	37.32	48.12	65.08
	50	27.56	36.46	40.06	50.88	68.48
	75	29.46	39.22	42.82	53.42	72.08
	100	31.16	40.92	45.36	56.18	76.54
	125	32.86	44.52	48.12	58.72	80.98
	150	34.76	47.28	51.72	61.48	84.80
	175	36.46	49.82	55.12	65.08	88.20
	200	38.38	52.58	58.72	68.48	93.28
	250	44.52	58.72	65.72	77.38	105.16
	300	51.72	65.72	74.84	89.04	115.76
	400	-	82.68	95.40	-	-
AB						

注：可调 50 加 50%，可调 75 加 75%，可调 100 加 100%。

亚德客型 MAL 铝合金迷你气缸	行程	缸径				
		16	20	25	32	40
	25	17.80	23.10	28.40	33.92	51.72
	50	19.50	25.02	31.16	35.62	56.60
	75	20.56	26.72	32.86	38.38	58.72
	100	22.26	28.40	34.76	40.06	62.32
	125	23.96	30.32	37.32	42.82	65.94
	150	25.86	31.16	39.22	44.52	67.84
	175	26.72	33.08	40.06	48.12	71.24
	200	28.40	35.62	42.82	51.72	76.54
	250	30.32	39.22	48.12	55.12	81.84
	300	35.62	44.52	51.72	58.72	85.44
	AB					

注：带磁 +7 元，可调加 50 加 50%，可调 75 加 75%，可调 100 加 100%。

CDJ2B (PB) 系列不锈钢迷你气缸	行程	缸径					
		10(双)	10(单)	12(双)	12(单)	16(双)	16(单)
	5	14.00	20.00	18.00	24.00	18.00	24.00
	10	14.00	20.00	18.00	24.00	18.00	24.00
	15	14.00	20.00	18.00	24.00	18.00	24.00
	20	14.00	20.00	18.00	24.00	18.00	24.00
	25	14.00	20.00	18.00	24.00	18.00	24.00
	30	14.00	20.00	18.00	24.00	18.00	24.00
	35	14.00	20.00	18.00	24.00	18.00	24.00
	40	14.00	20.00	18.00	24.00	18.00	24.00
	45	14.00	20.00	18.00	24.00	18.00	24.00
	50	14.00	20.00	18.00	24.00	18.00	24.00
	60	18.00	24.00	22.00	28.00	22.00	28.00
	75	18.00	24.00	22.00	28.00	22.00	28.00
	100	18.00	24.00	22.00	28.00	22.00	28.00
	125	22.00	28.00	27.00	34.00	27.00	34.00
	150	22.00	28.00	27.00	34.00	27.00	34.00
	175	29.00	36.00	33.00	38.00	33.00	38.00
<b>YR</b>	200	29.00	36.00	33.00	38.00	33.00	38.00

CJPB 单动系列	行程	缸径					
		4	6	8	10	12	15
	5	43.20	10.80	21.60	10.80	26.00	21.60
	10	43.20	10.80	21.60	10.80	26.00	21.60
	15	43.20	12.96	21.60	15.20	26.00	26.00

**AF**  
注：CJPS 加 8 元，超出行程每 +5 行程 +12 元。

CDJPB/CDJP2B 双动系列	行程	缸径		
		6	10	15/16
	5	30.00	41.00	54.00
	10	30.00	41.00	54.00
	15	30.00	41.00	54.00

**AF**  
注：超出行程每 +5 行程 +12 元。

CDJPT/CDJP2T 双动系列	行程	缸径		
		6	10	15/16
	5	52.00	63.00	75.00
	10	52.00	63.00	75.00
	15	52.00	63.00	75.00

**AF**  
注：超出行程每 +5 行程 +12 元。

CJ1B 系列针型气缸	型号	单价
	4X5	13.00
	4X10	13.00
	4X15	17.00
	4X20	26.00

AF

CDUJB 小型自由安装气缸	行程	缸径					
		6	8	10	12	16	20
	4D/DM	28.00	28.00	33.00	-	-	-
	5D/DM	-	-	-	43.00	54.00	66.00
	6D/DM	28.00	28.00	33.00	-	-	-
	8D/DM	36.00	33.00	37.00	-	-	-
	10D/DM	41.00	33.00	37.00	43.00	54.00	68.00
	15D/DM	41.00	38.00	41.00	48.00	60.00	74.00
	20D/DM	50.00	38.00	41.00	48.00	60.00	74.00
	25D/DM	54.00	46.00	47.00	52.00	68.00	82.00
	30D/DM	54.00	46.00	47.00	52.00	68.00	82.00
	40D/DM	-	-	-	-	-	92.00

AF

注：单动4、6、8缸径+12元，单动12、16、20缸径+20元，CDUJS同价。

CRA1/CDRA1 系列摆动气缸 (齿轮齿条式)	度数	缸径				
		32	50	63	80	100
	90°	388.00	580.00	774.00	1026.08	2828.00
	180°	456.00	678.00	910.00	1184.02	3214.00

AC

注：轴 W 型 X 型 Y 型 Z 型加 15%，U 型加 20%。

MSQB (HRQ) 系列摆动气缸 (齿轮齿条式)	可选项	缸径						
		10	20	30	50	70	100	200
	A	216.00	280.00	344.00	560.00	774.00	990.00	1292.00
	R	366.00	452.00	516.00	774.00	1032.00	1248.00	1722.00
	L2	410.00	496.00	580.00	860.00	-	-	-
	L3	452.00	538.00	646.00	926.00	-	-	-
	MSQA	194.00	244.00	244.00	292.00	-	-	-
	齿轮	50.00	74.00	98.00	122.00	-	-	-
	缓冲+	170.00	194.00	194.00	244.00	-	-	-

AC

注：L2/L3 不含缓冲价格，如需缓冲器价格另加。

CRQ2B/CDRQ2B 系列薄型 摆动气缸 (齿轮齿条式)	度数	缸径				
		10	15	20	30	40
	90°	302.00	334.00	378.00	430.00	646.00
	180°	324.00	378.00	430.00	506.00	732.00

AC

注：W 加 50 元。

MK 系列回转夹紧气缸	行程	缸径							
		12	16	20	25	32	40	50	63
	10	94.60	52.80	63.80	74.80	85.80	99.00	195.80	250.80
	20	110.00	63.80	74.80	85.80	96.80	110.00	213.40	272.80
	30	-	85.80	96.80	107.80	118.80	132.00	237.60	299.20
	50	-	-	-	-	147.40	154.00	303.60	347.60
	横臂	13.20	13.20	13.20	13.20	17.60	17.60	22.00	22.00

AQ

注：MK2B 加 30%

QCK	行程	缸径							
		12	16	20	25	32	40	50	63
	10	123.20	92.40	116.60	123.20	147.40	171.60	253.00	308.00
	20	127.60	96.80	123.20	127.60	156.20	182.60	268.40	325.60
	30	-	103.40	127.60	134.20	167.20	191.40	286.00	345.40
	50	-	-	-	-	187.00	211.20	308.00	382.80
	法兰	28.60	28.60	28.60	28.60	28.60	39.60	39.60	39.60

AQ

气动手指系列



AC

型号	缸径							
	6	10	12	16	20	25	32	40
MHZ2	278.00	108.00	-	108.00	150.00	216.00	324.00	430.00
MHY2	-	150.00	-	172.00	216.00	280.00	-	-
MHC2	-	86.00	-	108.00	150.00	172.00	386.00	-
HFY	-	194.00	-	204.00	226.00	258.00	474.00	-
MHK2	-	-	382.00	466.00	594.00	700.00	-	-
MHKL2	-	-	488.00	572.00	700.00	806.00	-	-
MHZL2	-	194.00	-	194.00	302.00	430.00	-	-

注：MHZ2、MHZL2：S、DN 加 14 元，C 加 24 元，D1、D2 加 24 元，D3 加 38 元；

MHC2：S 加 14 元，C 加 24 元，D2 加 24 元；

MHY2：D2 加 24 元，此价格表不含运费。

MHL2 系列阔型气动手指 (平行开闭式)	可选项	缸径					
		10	16	20	25	32	40
	D	216.00	280.00	386.00	516.00	754.00	1098.00
	D1	302.00	386.00	516.00	666.00	926.00	1356.00
	D2	386.00	496.00	646.00	818.00	1140.00	1614.00

AC

MHT2 系列肘节型气爪	型号	缸径			
		32	40	50	63
	MHT2	582.00	808.00	948.00	1034.00

AC

MHF2 系列薄型气爪	可选项	缸径			
		8	12	16	20
	D	430.00	430.00	478.00	602.00
	D1	468.00	468.00	576.00	700.00
	D2	576.00	576.00	690.00	836.00
	DR	452.00	452.00	506.00	624.00
	D1R	490.00	490.00	602.00	722.00
	D2R	602.00	602.00	710.00	860.00

AC

MHW2 系列气爪 (支点开闭型) 齿轮齿条 180°开闭	可选项	缸径				
		20	25	32	40	50
	D	742.00	848.00	1060.00	1696.00	2120.00
	D1	848.00	954.00	1166.00	1908.00	2438.00

AC

HDM 系列角度型机械爪	型号	缸径				
		10	16	20	25	32
	HDM	-	356.00	560.00	666.00	818.00
	HDP	254.00	296.00	382.00	508.00	742.00

AC

MHS 系列气爪 (平行开闭型 / 圆柱形爪体气缸)	型号	缸径									
		16	20	25	32	40	50	63	80	100	125
	MHS2	362.00	394.00	404.00	434.00	754.00	864.00	1032.00	-	-	-
	MHS3	386.00	394.00	434.00	464.00	774.00	870.00	1032.00	1240.00	1446.00	2152.00
	MHS4	414.00	434.00	462.00	498.00	904.00	1032.00	1292.00	-	-	-
	MHSL3	742.00	796.00	848.00	902.00	954.00	1166.00	1294.00	2068.00	2968.00	4452.00
	AC MSHH3	848.00	954.00	1008.00	1060.00	1166.00	1272.00	1590.00	2120.00	-	-

## 夹紧气缸

CK1A 系列夹紧气缸	行程	缸径				
		50	75	100	125	150
	40	323.30	333.90	344.50	355.10	365.70
	50	333.90	344.50	355.10	365.70	377.36
	63	333.90	344.50	355.10	365.70	377.36
	AC 80	689.00	710.20	731.40	753.66	774.86

注：CKG1 加 48 元。

## 无杆气缸

MY1B 系列机械式无杆气缸	行程	缸径					
		16	20	25	32	40	50
	100	1506.26	1506.26	1506.26	2475.10	3012.52	3981.36
	200	1506.26	1506.26	1506.26	2475.10	3012.52	3981.36
	300	1506.26	1506.26	1506.26	2475.10	3012.52	3981.36
	400	1506.26	1506.26	1506.26	2475.10	3012.52	3981.36
	500	1721.44	1721.44	1721.44	2690.28	3227.70	4196.54
	600	1936.62	1936.62	1936.62	2905.46	3442.88	4411.72
	700	2151.80	2151.80	2151.80	3120.64	3658.06	4626.90
	800	2366.98	2366.98	2366.98	3335.82	3873.24	4842.08
	900	2582.16	2582.16	2582.16	3551.00	4088.42	5057.26
	1000	2797.34	2797.34	2797.34	3766.18	4303.60	5272.44
	每 100 行程 +	243.60	243.60	243.60	243.60	243.60	243.60
	带 L、H+	-	438.00	487.20	536.40	536.40	-
	AC 带 A+	243.60	243.60	243.60	243.60	243.60	-

MY1M 系列机械式无杆气缸	行程	缸径		
		16	20	25
	100	1721.44	1721.44	1829.56
	200	1721.44	1721.44	1829.56
	300	1721.44	1721.44	1829.56
	400	1721.44	1721.44	1829.56
	500	1936.62	1936.62	2044.74
	600	2151.80	2151.80	2259.92
	700	2366.98	2366.98	2475.10
	800	2582.16	2582.16	2690.28
	900	2797.34	2797.34	2905.46
	1000	3012.52	3012.52	3120.64
	每 100 行程 +	243.60	243.60	243.60
	带 L+	414.00	414.00	438.00
	带 H+	-	438.00	487.20
	带 A+	243.60	243.60	243.60



AC

CY1B/CY3B(RMS) 系列磁 偶式无杆气缸	行程	缸径								
		6	10	15	20	25	32	40	50	63
	0-100	308.00	164.00	204.00	308.00	410.00	502.00	838.00	1704.00	1916.00
	101-200	326.00	180.00	222.00	330.00	432.00	534.00	876.00	1770.00	2002.00
	201-300	342.00	194.00	238.00	350.00	456.00	566.00	914.00	1834.00	2088.00
	301-400	360.00	208.00	256.00	372.00	480.00	598.00	954.00	1898.00	2174.00
	401-500	378.00	224.00	274.00	394.00	504.00	630.00	992.00	1964.00	2260.00
	501-600	-	-	294.00	416.00	528.00	662.00	1030.00	2048.00	2366.00
	601-700	-	-	316.00	436.00	550.00	696.00	1070.00	2134.00	2476.00
	701-800	-	-	338.00	458.00	574.00	728.00	1108.00	2220.00	2582.00
	801-900	-	-	360.00	480.00	620.00	760.00	1146.00	2306.00	2690.00
	901-1000	-	-	380.00	502.00	644.00	792.00	1186.00	2372.00	2798.00
	1001-1100	-	-	-	534.00	678.00	836.00	1240.00	2480.00	2948.00
	1101-1200	-	-	-	566.00	712.00	878.00	1294.00	2586.00	3098.00
	1201-1300	-	-	-	598.00	746.00	922.00	1348.00	2694.00	3248.00
	1301-1400	-	-	-	630.00	782.00	964.00	1402.00	2802.00	3400.00
	1401-1500	-	-	-	662.00	816.00	1008.00	1454.00	2910.00	3552.00
	1501-1600	-	-	-	696.00	850.00	1050.00	1508.00	3060.00	3744.00
	1601-1700	-	-	-	728.00	884.00	1092.00	1562.00	3210.00	3938.00
	1701-1800	-	-	-	760.00	920.00	1136.00	1616.00	3362.00	4132.00
	1801-1900	-	-	-	792.00	954.00	1178.00	1670.00	3532.00	4324.00
	1901-2000	-	-	-	824.00	988.00	1222.00	1724.00	3706.00	4518.00



AC

注：CY1B-A 气缓冲 10-25 缸径加 148 元，32-40 缸径加 244 元，LB 支架 6、10、15 缸径 14 元，20 缸径 16 元，25、32 缸径 20 元，40 缸径 24 元，此价格不含运费。

无杆气缸

CY1S (RMT) 系列磁偶式无杆气缸	行程	缸径						
		6	10	15	20	25	32	40
	0-100	534.00	398.00	452.00	650.00	738.00	830.00	1082.00
	101-200	568.00	420.00	478.00	690.00	776.00	882.00	1174.00
	201-300	602.00	442.00	504.00	728.00	816.00	936.00	1268.00
	301-400	638.00	464.00	532.00	766.00	854.00	990.00	1362.00
	401-500	672.00	484.00	560.00	806.00	892.00	1044.00	1456.00
	501-600	-	-	590.00	844.00	932.00	1098.00	1552.00
	601-700	-	-	624.00	884.00	974.00	1152.00	1646.00
	701-800	-	-	666.00	926.00	1014.00	1216.00	1740.00
	801-900	-	-	-	966.00	1054.00	1280.00	1836.00
	901-1000	-	-	-	1008.00	1094.00	1356.00	1930.00
	1001-1100	-	-	-	1048.00	1138.00	1432.00	2026.00
	1101-1200	-	-	-	1088.00	1180.00	1506.00	2124.00
	1201-1300	-	-	-	1130.00	1224.00	1592.00	2220.00
	1301-1400	-	-	-	1174.00	1284.00	1678.00	2324.00
	1401-1500	-	-	-	1216.00	1344.00	1764.00	2432.00



AC

注：B带液压缓冲气10和15加172元，20加196元，25加244元，32和40加297元，此价格不含运费。

CY1R 系列磁偶式 无杆气缸 / 直接安装	行程	缸径								
		6	10	15	20	25	32	40	50	63
	0-100	398.00	206.00	260.00	394.00	516.00	642.00	1010.00	2128.00	2324.00
	101-200	420.00	222.00	278.00	416.00	540.00	674.00	1048.00	2224.00	2452.00
	201-300	442.00	236.00	294.00	436.00	564.00	706.00	1088.00	2322.00	2582.00
	301-400	464.00	252.00	312.00	458.00	588.00	738.00	1126.00	2418.00	2712.00
	401-500	488.00	268.00	330.00	480.00	612.00	770.00	1164.00	2516.00	2840.00
	501-600	-	-	350.00	502.00	634.00	802.00	1204.00	2624.00	2970.00
	601-700	-	-	372.00	524.00	658.00	836.00	1242.00	2730.00	3100.00
	701-800	-	-	394.00	544.00	682.00	868.00	1280.00	2838.00	3228.00
	801-900	-	-	416.00	566.00	728.00	898.00	1320.00	2948.00	3358.00
	901-1000	-	-	436.00	588.00	750.00	932.00	1358.00	3056.00	3486.00
	1001-1100	-	-	-	620.00	786.00	976.00	1410.00	3164.00	3614.00
	1101-1200	-	-	-	652.00	820.00	1018.00	1466.00	3292.00	3744.00
	1201-1300	-	-	-	684.00	854.00	1062.00	1518.00	3400.00	3874.00
	1301-1400	-	-	-	716.00	890.00	1104.00	1574.00	3508.00	4002.00
	1401-1500	-	-	-	748.00	924.00	1146.00	1626.04	3614.00	4218.00
	1501-1600	-	-	-	782.00	958.00	1190.00	1681.16	3766.00	4390.00
	1601-1700	-	-	-	814.00	992.00	1232.00	1734.16	3916.00	4562.00
	1701-1800	-	-	-	846.00	1026.00	1278.00	1788.22	4068.00	4734.00
	1801-1900	-	-	-	878.00	1062.00	1320.00	1841.22	4238.00	4906.00
	1901-2000	-	-	-	910.00	1094.00	1362.00	1896.34	4604.00	5078.00



AC

注：G10-15加74元，G20-63加124元。

G：集中配管



### 无杆气缸

CY1L (RMTL) 系列磁偶式无杆气缸 (滑尺型 / 球轴承)	行程	缸径						
		6	10	15	20	25	32	40
	0-100	736.00	546.00	630.00	968.00	1070.00	1190.00	1480.00
	101-200	760.00	568.00	658.00	1008.00	1108.00	1242.00	1574.00
	201-300	808.00	590.00	686.00	1146.00	1146.00	1294.00	1670.00
	301-400	856.00	590.00	714.00	1084.00	1186.00	1348.00	1760.00
	401-500	910.00	612.00	744.00	1128.00	1226.00	1402.00	1856.00
	501-600	-	-	774.00	1194.00	1292.00	1506.00	2006.00
	601-700	-	-	808.00	1238.00	1336.00	1560.00	2102.00
	701-800	-	-	840.00	1280.00	1376.00	1614.00	2200.00
	801-900	-	-	876.00	1324.00	1420.00	1678.00	2296.00
	901-1000	-	-	932.00	1366.00	1462.00	1742.00	2490.00
	1001-1100	-	-	-	1420.00	1506.00	1808.00	2586.00
	1101-1200	-	-	-	1474.00	1550.00	1872.00	2682.00
	1201-1300	-	-	-	1528.00	1592.00	1948.00	2780.00
	1301-1400	-	-	-	1582.00	1656.00	2022.00	2876.00
	1401-1500	-	-	-	1636.00	1722.00	2108.00	3012.00



AC

注：B 带液压缓冲气 10 和 15 加 172 元，20 加 196 元，25 加 244 元，32 和 40 加 294 元，此价格不含运费。

### 气动执行器

单动气动执行器	型号	单价	双动气动执行器	型号	单价
	AT52S	172.80		AT52D	129.60
	AT63S	226.80		AT63D	183.60
	AT75S	280.80		AT75D	226.80
	AR83S	367.20		AR83D	280.80
	AT92S	453.60		AT92D	356.40
	AT105S	572.40		AT105D	453.60
	AT125S	788.40		AT125D	594.00
	AT140S	1209.60		AT140D	874.80
	AT160S	1803.60		AT160D	1296.00
	AT190S	2646.00		AT190D	2030.40
	AT210S	3391.20		AT210D	2613.60
	AT240S	5205.60		AT240D	4233.60
	AT270S	7300.80		AT270D	5896.80



WF



WF

ADN (FESTO 型) 薄型缸系列	行程	缸径										
		12	16	20	25	32	40	50	63	80	100	125
	5	53.68	55.44	60.72	74.80	84.48	95.04	121.44	146.08	200.64	316.80	836.00
	10	53.68	56.32	61.60	75.68	86.24	97.68	124.08	147.84	205.04	321.20	836.00
	15	54.56	58.08	63.36	77.44	88.88	99.44	125.84	150.48	209.44	325.60	847.44
	20	55.44	58.96	64.24	78.32	90.64	102.08	128.48	152.24	213.84	330.00	858.00
	25	56.32	59.84	65.12	79.20	93.28	103.84	130.24	154.88	218.24	334.40	869.44
	30	58.08	60.72	66.88	80.08	95.04	106.48	132.88	156.64	222.64	338.80	880.00
	35	58.96	62.48	67.76	81.84	97.68	108.24	134.64	159.28	227.04	343.20	891.44
	40	59.84	63.36	68.64	82.72	99.44	110.88	137.28	161.04	231.44	347.60	902.00
	45	60.72	64.24	69.52	83.60	102.08	112.64	139.04	163.68	235.84	352.00	924.00
	50	62.48	65.12	70.40	84.48	103.84	115.28	141.68	165.44	240.24	356.40	946.00
	55			72.16	86.24	106.48	117.04	143.44	168.08	244.64	360.80	968.00
	60			73.04	88.00	108.24	119.68	146.08	169.84	249.04	365.20	990.00
	65			73.92	90.64	110.88	121.44	147.84	172.48	253.44	369.60	1012.00
	70			74.80	92.40	112.64	124.08	150.48	174.24	257.84	378.40	1034.00
	75			76.56	95.04	115.28	125.84	152.24	176.88	262.24	382.80	1056.00
	80			77.44	96.80	117.04	128.48	154.88	178.64	266.64	391.60	1078.00
	90			78.32	101.20	121.44	132.88	159.28	183.04	275.44	400.40	1100.00
	100			80.96	105.60	125.84	139.04	165.44	194.48	284.24	416.24	1122.00
	(+5mm)	0.96	1.92	1.92	2.88	2.88	2.88	3.84	4.80	4.80	7.68	12.48
	外牙	2.88	2.88	2.88	2.88	4.80	4.80	5.76	7.68	9.60	12.48	19.20
<b>AH</b>	耐高温另加	24.00	28.80	36.48	48.00	52.80	60.48	84.48	96.00	120.00	144.00	192.00

备注：1、ADN-S2(双轴气缸)另加35%；

2、ADN-S3(可调气缸)可调行程1-50另加40%，可调行程51-100另加50%，可调行程大于150另加80%；

3、ADNGF按标准加80%；

### ADN (FESTO 型) 薄型缸 附件

型号	缸径										
	12	16	20	25	32	40	50	63	80	100	
法兰 FA/FB	28.80	28.80	33.60	36.00	38.40	40.80	57.60	69.60	108.48	137.28	
单耳环 CA	36.00	36.00	40.80	48.00	16.80	19.20	24.00	31.20	38.40	57.60	
双耳环 CB+PIN	38.40	38.40	43.20	50.40	20.16	24.00	31.68	38.40	57.60	84.48	
斜耳环 CR	-	-	-	-	16.80	19.20	24.00	28.80	45.60	67.20	
脚架 LB <b>AH</b>	24.00	24.00	28.80	28.80	22.08	26.88	36.48	36.48	67.20	67.20	



CQ2A 超长行程 薄型气缸系列	行程	缸径					
		32	40	50	63	80	100
	125	132.88	161.92	201.52	201.52	371.36	483.12
	150	144.32	172.48	212.96	212.96	395.12	513.92
	175	154.88	182.16	225.28	225.28	418.88	545.60
	200	164.56	191.84	236.72	236.72	441.76	577.28
	250	183.92	211.20	262.24	262.24	489.28	639.76
	300	203.28	230.56	287.76	287.76	535.92	702.24
	400	262.24	289.52	345.84	345.84	630.08	827.20
	500	320.32	348.48	404.80	404.80	723.36	952.16
	外牙	5.76	5.76	7.68	7.68	9.60	13.44
	带磁性	15.36	16.32	21.12	21.12	28.80	34.56

AH

ADVU (FESTO 型) 薄型缸系列	行程	缸径										
		12	16	20	25	32	40	50	63	80	100	125
	5	64.24	64.24	70.40	74.80	90.64	97.68	118.80	161.04	227.04	429.44	616.88
	10	64.24	64.24	70.40	75.68	90.64	99.44	121.44	162.80	231.44	440.88	627.44
	15	65.12	65.12	73.04	75.68	93.28	102.08	123.20	167.20	235.84	451.44	638.88
	20	65.12	65.12	73.04	78.32	95.04	103.84	125.84	171.60	240.24	462.88	649.44
	25	66.00	66.00	73.92	78.32	95.92	106.48	128.48	174.24	244.64	473.44	660.88
	30	66.00	66.00	73.92	80.08	97.68	108.24	130.24	178.64	249.04	484.88	671.44
	35	68.64	68.64	74.80	80.08	97.68	110.88	132.00	183.04	253.44	495.44	682.88
	40	68.64	68.64	74.80	82.72	99.44	112.64	136.40	184.80	257.84	506.88	693.44
	45	68.64	68.64	77.44	82.72	102.08	115.28	139.04	189.20	262.24	517.44	704.88
	50	70.40	70.40	77.44	84.48	102.08	117.04	139.04	193.60	266.64	528.88	715.44
	55	70.40	70.40	79.20	84.48	103.84	117.04	140.80	198.00	271.04	539.44	726.88
	60	70.40	70.40	79.20	85.36	106.48	119.68	145.20	200.64	275.44	550.88	737.44
	65	73.04	73.04	79.20	87.12	107.36	121.44	147.84	205.04	279.84	561.44	748.88
	70	73.04	73.04	81.84	87.12	108.24	124.08	148.72	207.68	284.24	572.88	759.44
	75	73.04	73.04	81.84	88.88	108.24	125.84	152.24	211.20	288.64	583.44	770.88
	80	73.92	74.80	83.60	88.88	110.88	128.48	154.00	215.60	293.04	594.88	781.44
	85	74.80	74.80	83.60	88.88	112.64	130.24	156.64	218.24	295.68	599.28	789.36
	90	74.80	74.80	84.48	91.52	112.64	132.88	157.52	222.64	297.44	605.44	803.44
	100	77.44	77.44	86.24	93.28	116.16	137.28	162.80	228.80	308.88	627.44	825.44
	(+5mm)	2.88	2.88	4.80	4.80	5.76	9.60	10.56	14.40	19.20	19.20	19.20
外牙	3.84	3.84	4.80	4.80	4.80	7.68	7.68	9.60	9.60	12.48	12.48	
耐高温 另加	24.00	28.80	36.48	48.00	52.80	60.48	84.48	96.00	120.00	144.00	192.00	

AH

- 备注：1、ADVU-S2(双轴气缸) 另加 35%；  
 2、ADVU-S3(可调气缸) 可调行程 1-50 另加 50%，可调行程 51-150 另加 60%；  
 3、ADVUL 型气缸加 80%；  
 4、以上价格均为面价；

CA2 铝合金标准气缸系列 (SMC)	行程	缸径				
		40	50	63	80	100
	>0-25	105.60	129.80	169.40	257.40	327.80
	>25-50	110.00	134.20	173.80	266.20	336.60
	>50-75	114.40	138.60	180.40	277.20	349.80
	>75-100	118.80	145.20	187.00	286.00	360.80
	>100-125	123.20	149.60	191.40	294.80	371.80
	>125-150	127.60	154.00	198.00	303.60	382.80
	>150-175	132.00	158.40	202.40	312.40	396.00
	>175-200	136.40	165.00	209.00	321.20	407.00
	>200-225	145.20	176.00	224.40	345.40	435.60
	>225-250	149.60	182.60	228.80	370.04	446.60
	>250-300	158.40	191.40	242.00	374.00	470.80
	>300-350	169.40	202.40	253.00	393.80	495.00
	>350-400	178.20	213.40	266.20	413.60	517.00
	>400-450	200.20	239.80	297.00	444.40	556.60
	>450-500	209.00	250.80	310.20	464.20	583.00
	>500-600	228.80	272.80	336.60	503.80	631.40
	>600-700	248.60	297.00	363.00	543.40	679.80
	>700-800	268.40	316.80	387.20	583.00	728.20
	>800-900	288.20	341.00	413.60	622.60	776.60
	>900-1000	308.00	363.00	437.80	662.20	827.20
	(+100mm)	24.00	28.80	31.20	50.40	62.40
	耐高温 -XB6	48.00	60.00	67.20	84.00	96.00
	<b>AH</b> 附磁性 CDA2B	4.80	7.20	8.64	10.56	12.00

注释：气缸防尘圈仅有 PDU 圈一种样式，活塞杆为不锈钢材质需另行报价。

### CA2 铝合金标准气缸附件

型号	缸径				
	40	50	63	80	100
法兰 FA/FB	31.20	36.00	52.80	81.60	98.40
单耳环 CA	31.68	36.00	48.00	69.60	98.40
双耳环 CB+PIN	33.60	40.80	57.60	81.60	108.00
斜耳环 CR					
脚架 LB (对)	14.40	19.20	21.60	31.20	40.80
中间轴销 TC	57.60	74.40	96.00	115.20	160.80
双叉接头 Y+PIN	40.80	57.60	57.60	79.20	91.20
单叉接头 I <b>AH</b>	33.60	40.80	40.80	72.00	72.00

备注：1、CA2W(双轴气缸)另加 35%;

2、CA2-XC8(可调气缸)可调行程 1-50 另加 40%，可调行程 51-150 另加 50%，可调行程大于 150 以上另加 80%;

3、以上价格均为面价;



MBB-Z 铝合金 标准气缸系列	行程	缸径						
		32	40	50	63	80	100	125
	>0-25	73.04	92.40	114.40	136.40	183.04	249.04	462.00
	>25-50	77.44	96.80	118.80	140.80	189.20	257.84	462.00
	>50-75	79.20	99.44	121.44	145.20	196.24	268.40	497.20
	>75-100	81.84	103.84	125.84	149.60	202.40	277.20	514.80
	>100-125	83.60	108.24	130.24	154.00	209.44	286.00	532.40
	>125-150	86.24	110.00	134.64	161.04	215.60	294.80	550.00
	>150-175	88.00	114.40	139.04	165.44	224.40	303.60	567.60
	>175-200	90.64	117.04	140.80	169.84	231.44	312.40	583.44
	>200-225	96.80	123.20	147.84	178.64	242.00	328.24	594.00
	>225-250	101.20	130.24	152.24	183.04	250.80	330.00	616.00
	>250-300	114.40	147.84	158.40	191.84	264.00	354.64	642.40
	>300-350	118.80	156.64	178.64	215.60	297.44	398.64	671.44
	>350-400	125.84	162.80	187.44	227.04	312.40	418.00	699.60
	>400-450	132.00	169.84	202.40	244.64	332.64	447.04	730.40
	>450-500	143.44	178.64	209.44	253.44	347.60	466.40	761.20
	>500-600	152.24	191.84	227.04	275.44	376.64	504.24	805.20
	>600-700	162.80	206.80	242.00	294.80	404.80	541.20	849.20
	>700-800	174.24	220.00	259.60	316.80	435.60	579.04	893.20
	>800-900	184.80	235.84	275.44	337.04	464.64	616.00	937.20
	>900-1000	196.24	250.80	288.64	356.40	492.80	653.84	990.00
	(+100mm)	14.40	19.20	24.00	31.68	43.20	55.68	60.48
	耐高温 -XB6	43.20	50.88	60.48	67.20	84.48	96.00	168.00
	附磁性 MDB <span style="background-color: black; color: white; padding: 0 2px;">AH</span>	4.80	4.80	7.68	8.64	10.56	12.48	19.20

注释：气缸防尘圈仅有 PDU 圈形式。MBB125 无 -Z 型。

### MBB-Z 铝合金标准气缸附件

型号	缸径						
	32	40	50	63	80	100	125
法兰 FA/FB	45.60	52.80	76.80	91.20	137.28	182.40	264.00
单耳环 CA	24.00	28.80	33.60	40.80	64.80	64.80	163.20
双耳环 CB+PIN	26.40	28.80	36.00	43.20	67.20	67.20	208.80
斜耳环 CR	28.80	33.60	36.00	48.00	72.00	72.00	180.00
脚架 LB (对)	18.00	21.60	28.80	43.20	50.40	50.40	108.00
中间轴销 TC	36.48	46.08	57.60	67.20	86.40	115.20	480.00
双叉接头 Y+PIN	36.00	43.20	72.00	72.00	115.20	115.20	340.80
单叉接头 I <span style="background-color: black; color: white; padding: 0 2px;">AH</span>	28.80	36.00	50.40	50.40	96.00	96.00	132.00

- 备注：1、MBW(双轴气缸)另加35%；  
 2、MB-XC8(可调气缸)可调行程1-50另加40%，可调行程51-150另加60%，可调行程大于150以上另加80%；  
 4、JSI系列(亚德客型)按MBB-Z的价格另加20%；  
 5、MKB按标准价格×3.5；  
 6、以上价格均为面价。

DNC (SE) 系列 15552 标准气缸系列 (费斯托型)	行程	缸径						
		32	40	50	63	80	100	125
	>0-25	105.60	128.48	165.44	193.60	279.84	330.88	646.80
	>25-50	110.00	134.64	174.24	206.80	293.04	348.48	677.60
	>50-75	114.40	141.68	183.04	218.24	306.24	363.44	706.64
	>75-100	118.80	150.48	194.48	228.80	323.84	381.04	734.80
	>100-125	123.20	156.64	203.28	240.24	341.44	398.64	761.20
	>125-150	127.60	163.68	213.84	255.20	359.04	425.04	787.60
	>150-175	132.00	169.84	225.28	264.00	374.88	442.64	816.64
	>175-200	136.40	176.88	234.08	275.44	389.84	462.88	844.80
	>200-225	140.80	183.04	242.88	286.00	403.04	480.48	871.20
	>225-250	147.84	190.08	249.04	299.20	420.64	499.84	904.64
	>250-300	158.40	205.04	266.64	319.44	449.68	535.04	959.20
	>300-350	167.20	218.24	297.44	347.60	486.64	572.88	994.40
	>350-400	176.00	235.84	328.24	382.80	517.44	623.04	1064.80
	>400-450	184.80	249.04	348.48	404.80	577.28	693.44	1196.80
	>450-500	193.60	266.64	367.84	431.20	609.84	733.04	1258.40
	>500-600	213.84	293.04	407.44	475.20	674.08	812.24	1381.60
	>600-700	235.84	315.04	442.64	521.84	737.44	887.04	1504.80
	>700-800	268.40	341.44	486.64	565.84	803.44	968.88	1630.64
	>800-900	301.84	367.84	524.48	611.60	869.44	1045.44	1751.20
	>900-1000	334.40	394.24	564.08	658.24	935.44	1124.64	1874.40
	(+100mm)	28.80	36.48	52.80	60.48	84.48	108.48	156.48
<b>AH</b>	耐高温 -H	76.80	84.48	96.00	120.00	148.80	168.00	180.48

DNC (SE) 系列气缸附件

型号	缸径						
	32	40	50	63	80	100	125
法兰 FA/FB	36.48	41.28	57.60	70.08	108.48	137.28	201.60
单耳环 CA	17.28	19.20	24.00	28.80	46.08	67.20	113.28
双耳环 CB+PIN	20.16	24.00	31.68	38.40	57.60	84.48	139.20
斜耳环 CR	17.28	19.20	24.00	28.80	46.08	67.20	113.28
脚架 LB (对)	9.60	12.48	12.48	17.28	19.20	24.00	48.00
前端摆轴 TC	60.48	62.40	72.00	84.48	103.68	163.20	228.48
双叉接头 Y+PIN	22.08	26.88	43.20	43.20	72.00	72.00	204.48
单叉接头 I <b>AH</b>	22.08	26.88	36.48	36.48	67.20	67.20	180.48

备注：1、DNC-S2(双轴气缸)另加 35%；

2、DNC-S3(可调气缸) 可调行程 1-50 另加 40%，可调行程 51-150 另加 50%，可调行程大于 150 以上另加 80%；

3、以上价格均为面价；

MGJ 系列微型带导杆气缸	型号	单价
	MGJ6-5	44.00
	MGJ6-10	44.00
	MGJ6-15	44.00
	MGJ6-20	56.00
	MGJ10-25	56.00
	MGJ10-30	56.00
	MGJ10-5	44.00
	MGJ10-10	44.00
	MGJ10-15	44.00
	MGJ10-20	56.00

AM

CDU 自由安装气缸	行程	缸径				
		10	16	20	25	32
	5	26.00	24.00	32.00	44.00	62.00
	10	26.00	24.00	32.00	46.00	64.00
	15	26.00	26.00	34.00	46.00	68.00
	20	26.00	26.00	36.00	48.00	72.00
	25	26.00	28.00	36.00	50.00	74.00
	30	26.00	28.00	38.00	52.00	78.00
	35	26.00	30.00	40.00	54.00	82.00
	40	26.00	30.00	40.00	56.00	84.00
	45	28.00	32.00	42.00	58.00	88.00
	50	28.00	32.00	44.00	60.00	92.00

AE

### 滑台气缸

SMC 型 MXH 滑台气缸	行程	缸径			
		6	10	16	20
	5	260.00	270.00	300.00	350.00
	10	270.00	280.00	320.00	350.00
	15	300.00	300.00	350.00	370.00
	20	350.00	350.00	360.00	420.00
	25	370.00	360.00	370.00	420.00
	30	380.00	370.00	380.00	430.00
	40	390.00	390.00	390.00	440.00
AJ	50	400.00	400.00	448.00	450.00
	60	418.00	418.00	458.00	458.00

**滑台气缸**

SMC 型 MXQ 滑台气缸	行程	缸径					
		6	8	12	16	20	25
	10	400.00	420.00	430.00	470.00	530.00	840.00
	20	410.00	430.00	450.00	488.00	550.00	860.00
	30	430.00	470.00	490.00	510.00	580.00	880.00
	40	520.00	530.00	550.00	570.00	630.00	1060.00
	50	530.00	540.00	580.00	600.00	700.00	1060.00
	75	-	568.00	680.00	700.00	850.00	1210.00
	100	-	-	800.00	860.00	950.00	1360.00
	125	-	-	-	1050.00	1200.00	1680.00
	150	-	-	-	-	1500.00	1920.00

AJ

SMC 型 MXS 滑台气缸	行程	缸径					
		6	8	12	16	20	25
	10	330.00	340.00	355.00	396.00	480.00	730.00
	20	345.00	350.00	370.00	418.00	495.00	750.00
	30	365.00	370.00	385.00	440.00	528.00	770.00
	40	380.00	385.00	418.00	468.00	575.00	830.00
	50	395.00	395.00	448.00	500.00	638.00	912.00
	75	-	450.00	495.00	590.00	720.00	1040.00
	100	-	-	668.00	780.00	858.00	1176.00
	125	-	-	-	960.00	1100.00	1440.00
	150	-	-	-	-	1375.00	1650.00

AJ

**增压缸**

MPT 标准型增压缸	缸径	行程						
		50	100	150	200	250	300	400
	50-1T	1210.00	1210.00	1276.00	1320.00	1320.00	1496.00	1584.00
	63-3T	1210.00	1210.00	1276.00	1320.00	1430.00	1496.00	1650.00
	80-5T	1716.00	1716.00	1760.00	1804.00	1870.00	1936.00	1800.00
	100-10T	2860.00	2860.00	2904.00	2970.00	3080.00	3124.00	3300.00
	125-15T	3520.00	3520.00	3630.00	3696.00	3784.00	3850.00	4180.00
	125-20T	4620.00	4620.00	4730.00	4730.00	4840.00	5060.00	5500.00
	125-25T	6930.00	7084.00	7260.00	7590.00	7920.00	8360.00	8800.00
	150-30T	8470.00	8800.00	9240.00	9680.00	10120.00	10560.00	11000.00
	160-40T	8800.00	9020.00	9240.00	9460.00	9900.00	10120.00	11440.00

AI

注：以上增压行程为：20mm 以内的价格，超出 20mm 请联系我公司询价。水平安装加 192。

MPT 总行程可调增压缸	缸径	行程						
		50	100	150	200	250	300	400
	50-1T	1650.00	1650.00	1716.00	1760.00	1760.00	1936.00	2024.00
	63-3T	1716.00	1716.00	1716.00	1760.00	1870.00	1936.00	2090.00
	80-5T	2244.00	2244.00	2310.00	2310.00	2420.00	2530.00	2640.00
	100-10T	3190.00	3190.00	3256.00	3256.00	3300.00	3300.00	3520.00
	125-15T	5060.00	5060.00	5280.00	5280.00	5500.00	5500.00	6160.00
	125-20T	5280.00	5280.00	5720.00	5720.00	6160.00	6160.00	6160.00
	125-25T	7700.00	7920.00	8360.00	8800.00	9460.00	9900.00	10560.00
	150-30T	9460.00	9680.00	10120.00	10560.00	11000.00	11440.00	12100.00
	160-40T	11660.00	12100.00	12760.00	13640.00	14300.00	14960.00	15840.00

AI

注：总行程可调范围为 50mm，增压行程为 20mm 内可调，增压行程超出范围请联系我公司。



压力机

单柱型台式气动压力机	型号	单价 (带控制箱)	单价 (不带控制箱)
	DTKJ-63	924	704
	DTKJ-63A	1320	1100
	DTKJ-80	1540	1320
	DTKJ-80A	1716	1496
	DTKJ-100	1760	1540
	DTKJ-125	2640	2420
	DTKJ-160	3520	3300

压力机

四柱气缸型 台式气动压力机	型号	单价 (带控制箱)	单价 (不带控制箱)
	DTKJ-100	3410	3190
	DTKJ-125	3520	3300
	DTKJ-160	3960	3740
	DTKJ-200	5060	4840
	DTKJ-250	6160	5940

四柱三板气缸型 台式气动压力机	型号	单价 (带控制箱)	单价 (不带控制箱)
	DTKJ-100	7260	7040
	DTKJ-125	7700	7480
	DTKJ-160	8360	8140
	DTKJ-200	9240	9020
	DTKJ-250	10560	10340

C式半弓型气缸 台式气动压力机	型号	单价 (带控制箱)	单价 (不带控制箱)
	DTKJ-100	6380	6160
	DTKJ-125	6820	6600
	DTKJ-160	7260	7040
	DTKJ-200	8140	7920
	DTKJ-250	9020	8800

四柱增压型台式压力机	型号	单价 (带控制箱)
	DTKJ-1T	6160
	DTKJ-3T	6600
	DTKJ-5T	7040
	DTKJ-10T	11440
	DTKJ-15T	14300
	DTKJ-20T	15840
	DTKJ-30T	23100
	DTKJ-50T	30360

四柱增压型 三板台式压力机	型号	单价 (带控制箱)
	DTKJ-1T	8800
	DTKJ-3T	9240
	DTKJ-5T	9460
	DTKJ-10T	15840
	DTKJ-15T	19800
	DTKJ-20T	23760
	DTKJ-30T	33000
	DTKJ-50T	48400

C型半弓增压型台式压力机	型号	单价 (带控制箱)
	DTKJ-1T	8360
	DTKJ-3T	8800
	DTKJ-5T	9900
	DTKJ-10T	16060

C型半弓增压型台式压力机	型号	单价 (带控制箱)
	DTKJ-15T	20240
	DTKJ-20T	25960
	DTKJ-30T	33000
	DTKJ-50T	48400

### SC 标准系列附件



FE

型号	缸径												
	16	20	25	32	40	50	63	80	100	125	160	200	250
单耳 CA	-	-	-	6.00	6.00	8.00	10.00	18.00	20.00	42.00	88.00	166.00	407.00
双耳 CB 带销	-	-	-	6.00	6.00	8.00	10.00	20.00	24.00	50.00	106.00	182.00	440.00
Y型带销	4.00	5.00	7.00	7.00	7.00	9.00	9.00	14.00	14.00	28.00	52.00	52.00	176.00
I型接头	3.00	4.00	5.00	5.00	7.00	9.00	9.00	14.00	14.00	31.00	48.00	48.00	220.00
法兰板 FA	-	-	-	8.00	8.00	10.00	14.00	24.00	30.00	58.00	110.00	176.00	407.00
脚架 LB (对)	-	-	-	4.00	5.00	7.00	9.00	16.00	20.00	40.00	78.00	146.00	286.00
中摆 TC	-	-	-	18.00	20.00	24.00	26.00	36.00	38.00	52.00	92.00	198.00	374.00
M座 (对)	-	-	-	28.00	29.00	29.00	29.00	48.00	48.00	66.00	122.00	144.00	264.00

### MAL 迷你缸附件



FE

型号	缸径				
	16	20	25	32	40
SDB 带销	5.80	6.60	6.60	7.00	8.80
法兰板 FA	2.40	2.80	2.80	3.40	4.80
LB (对)	5.00	6.00	6.00	8.00	9.00

### CJ/CM/CG 迷你缸附件



FE

型号	缸径					
	10	16	20	25	32	40
LB	5.60	6.00	6.60	8.40	8.40	12.00
FA	3.80	4.00	4.80	6.00	6.00	8.80

浮动接头 / 鱼眼接头	型号	品名		
		浮动接头	鱼眼接头	
	M4*0.7	7.20	8.00	
	M5*0.8	7.20	5.00	
	M6*1	7.20	6.00	
	M8*1.25	14.00	8.00	
	M10*1.25	16.00	10.00	
	M12*1.25	20.40	12.00	
	M14*1.5	23.80	16.00	
	M16*1.5	33.80	20.00	
	M18*1.5	35.60	28.00	
	M20*1.5	43.00	34.00	
	M22*1.5	55.00	44.00	
	M27*2	74.80	80.00	
	M36*2	178.20	132.00	
	M42*2	-	198.00	
	<b>FE</b>			

SMC 型浮动接头	型号	品名		
		JA	JAF	
  	气立可 M6*1	20.00	-	
	M8*1.25	22.00	39.60	
	M10*1.25	24.20	50.60	
	M10*1.5	26.40	55.00	
	M12*1.25	37.40	66.00	
	M12*1.75	39.60	70.40	
	M14*1.5	39.60	70.40	
	M16*1.5	57.20	110.00	
	M18*1.5	64.80	110.00	
	M20*1.5	89.00	154.00	
	M22*1.5	89.10	154.00	
	M26*1.5	242.00	297.00	
	M27.2	242.00	297.00	
	<b>FE</b>			

### IS06431/QGB/MCMBB 气缸附件

型号	缸径							
	16	20	32	40	50	63	80	100
单耳 CA	-	-	12.10	14.30	16.50	22.00	37.40	48.40
双耳 CB 带销	-	-	13.20	15.40	18.70	23.10	41.80	52.80
法兰 FA	-	-	13.20	15.40	19.80	24.20	44.00	52.80
脚架 LB (对)	-	-	7.00	8.00	18.00	19.80	24.00	28.60
Y型 带销 <b>FE</b>	6.60	7.70	15.40	20.24	40.70	40.70	70.40	70.40

### MOB 油缸附件

型号	缸径							
	16	20	32	40	50	63	80	100
单耳 CA	-	-	17.60	19.80	24.20	41.80	68.20	96.80
双耳 CB 带销	-	-	19.80	22.00	26.40	44.00	74.80	103.40
法兰 FA	-	-	18.70	20.90	20.90	30.80	68.20	79.20
脚架 LB (对)	-	-	9.90	12.10	15.40	18.70	22.00	44.00
Y型	-	-	19.80	19.80	19.80	27.72	49.50	59.40
I型 <b>FE</b>	-	-	19.80	19.80	19.80	27.50	49.50	59.40

型号	缸径							
	16	20	32	40	50	63	80	100
Y型			19.80	19.80	19.80	27.72	49.50	59.40
I型			19.80	19.80	19.80	27.72	49.50	59.40
法兰 FA	-	-		33.00	46.20	50.60	81.40	114.40
单耳 CA	-	-	-	26.40	33.00	50.60	77.00	105.60
双耳 CB 不带销	-	-	-	28.60	35.20	55.00	83.60	114.40
脚架 LB (对)	FE	-	-	15.84	26.40	34.32	66.00	79.20

DBF 刹车气缸	缸径				
	DBF-L8	DBF-L10	DBF-L15	DBF-L20	ZDBF-10(新款)
	299.38	299.38	299.38	299.38	291.06
AA					

TXJ 系列夹具	型号	单价
	1615D	90.00
	1615S	90.00
	2015D	110.00
	2015S	110.00
HK		



ALC/JGL 系列杠杆气缸	型号	缸径						
		25	32	40	50	63	80	100
	ALC 不带磁	50.40	56.80	69.40	90.40	115.60	252.00	400.00
	JGL 带磁	60.00	66.00	84.00	110.00	136.00	284.00	442.00
	斜边另加	6.00	6.00	6.00	8.00	8.00	14.00	24.00
AA								

ACKL / ACKR 转角夹紧气缸	度数	缸径				
		25	32	40	50	63
	转角 90°	70.40	103.40	125.40	165.00	242.00
	AD					

SRCL / SRCR 转角下压气缸	度数	缸径				
		25	32	40	50	63
	转角 90°	70.40	103.40	125.40	165.00	242.00
	AD					

# 执行元件 替代进口

## IMPORT SUBSTITUTION

精品型 SC 气缸	行程	缸径													
		32 铝合金	40 铝合金	50 铝合金	63 铝合金	80 铝合金	100 铝合金	125 铝合金	160 铝合金	160 铁	200 铝合金	200 铁	250 铁	320 铁	
	25	47.04	55.86	68.43	86.73	127.89	166.11	261.80	463.40	619.08	864.36	993.37	1909.46	4797.80	
	50	49.98	60.27	74.90	91.14	133.77	174.93	273.00	477.40	637.56	905.52	1041.67	1927.17	4891.18	
	75	52.92	63.21	79.39	95.55	141.12	183.75	284.20	494.20	657.58	945.21	1086.75	1960.98	4981.34	
	100	55.86	67.62	83.89	101.43	148.47	192.57	295.40	529.20	669.90	990.78	1139.88	2012.50	5068.28	
	125	58.80	72.80	88.38	105.84	155.82	201.39	308.00	550.20	689.92	1018.71	1172.08	2064.02	5180.98	
	150	61.74	74.97	92.88	111.72	163.17	210.21	319.20	564.20	708.40	1049.58	1207.50	2142.91	5292.07	
	175	64.68	77.91	97.37	116.13	170.52	219.03	330.40	582.40	731.50	1070.16	1230.04	2189.60	5401.55	
	200	67.62	82.32	101.86	122.01	177.87	227.85	341.60	597.80	751.52	1095.15	1259.02	2263.66	5512.64	
	250	73.50	89.67	105.27	133.77	190.34	240.81	365.40	628.60	790.02	1133.37	1304.10	2503.55	5733.21	
	300	77.11	97.02	112.48	145.53	206.21	258.12	387.80	674.80	847.00	1170.12	1345.96	2645.23	5966.66	
	350	82.82	104.37	121.13	154.29	222.07	275.42	411.60	708.40	890.12	1218.63	1400.70	2785.30	6206.55	
	400	88.54	111.72	129.78	165.83	237.93	292.73	434.00	758.80	968.66	1265.67	1455.44	2925.37	6427.12	
	450	94.25	115.67	136.99	177.37	253.79	310.03	457.80	791.00	999.46	1315.65	1513.40	3067.05	6647.69	
	500	98.00	122.81	144.20	188.90	269.65	327.33	480.20	826.00	1039.50	1365.63	1569.75	3207.12	6881.14	
	550	103.60	130.20	152.60	199.72	284.80	345.36	502.60	858.20	1078.00	1415.61	1627.71	3347.19	7102.52	
	600	109.20	137.09	161.50	210.53	299.94	363.38	526.40	891.80	1155.00	1465.59	1685.67	3487.26	7323.89	
	650	114.80	144.20	170.80	221.35	315.08	381.41	548.80	980.00	1239.32	1505.28	1730.75	3628.14	7544.46	
	700	120.40	151.37	178.81	232.16	330.22	399.43	572.60	1015.00	1323.65	1544.97	1777.44	3769.01	7765.03	
	750	126.00	158.20	184.80	242.98	345.36	417.46	593.60	1051.40	1370.31	1625.82	1869.21	3909.89	7985.60	
	800	131.60	165.65	190.40	253.79	360.50	435.48	614.60	1086.40	1416.97	1706.67	1962.59	4050.76	8206.17	
	850	137.20	173.60	198.80	260.60	369.95	446.64	632.80	1120.00	1463.63	1766.94	2031.82	4235.91	8427.55	
	900	142.80	179.93	207.20	267.40	379.40	457.80	652.40	1156.40	1510.29	1827.21	2101.05	4421.06	8648.92	
	950	148.40	187.60	215.60	277.90	394.10	475.30	674.80	1192.80	1556.96	1908.06	2194.43	4564.35	8869.49	
	1000	154.00	194.21	224.00	288.40	408.80	492.80	697.20	1227.80	1603.62	1987.44	2286.20	4707.64	9090.06	
	加磁面价	7.00	7.00	7.00	7.00	7.00	9.80	21.00	42.00	-	73.50	-	-	-	
	进口圈非 Eu 防尘 + 面价	8.40	8.40	11.20	14.00	21.00	28.00	42.00	70.00	-	-	-	-	-	
	AN 耐高温非 EU 防尘 + 面价	28.00	28.00	35.00	42.00	56.00	70.00	119.00	224.00	-	-	-	-	-	

注：非标规格另加 10-50%，双出加 45%，单作用加 65%，50 以内可调加 50%，50-100 可调加 65%。

平行手指	型号	单价
	MHZA2-6D	210.00
	MHZ2-6D	210.00
	MHZ2-10D	123.90
	MHZ2-16D	123.90
	MHZ2-20D	178.50
	MHZ2-25D	241.50
	MHZ2-32D	346.50
	MHZ2-40D	462.00
	MHZL2-10D	184.80
	MHZL2-16D	184.80
	MHZL2-20D	273.00
	MHZL2-25D	367.50

平行手指	型号	单价
	MHZA2-6D1	231.00
	MHZ2-6D1	231.00
	MHZ2-10D1	144.90
	MHZ2-16D1	144.90
	MHZ2-20D1	199.50
	MHZ2-25D1	262.50
	MHZ2-32D1	367.50
	MHZ2-40D1	483.00
	MHZL2-10D1	205.80
	MHZL2-16D1	205.80
	MHZL2-20D1	294.00
	MHZL2-25D1	388.50

注：基本型 D 与 D2、D3、DN、S 型同样价格。

平行手指	型号	单价
	MHZA2-6C	252.00
	MHZ2-6C	252.00
	MHZ2-10C	165.90
	MHZ2-16C	165.90
	MHZ2-20C	220.50
	MHZ2-25C	283.50
	MHZ2-32C	388.50
	MHZ2-40C	504.00
	MHZL2-10C	226.80
	MHZL2-16C	226.80
	MHZL2-20C	315.00
	MHZL2-25C	409.50

宽型手指	型号	单价
	MHL2-10D	294.00
	MHL2-16D	336.00
	MHL2-20D	420.00
	MHL2-25D	541.80
	MHL2-10D1	420.00
	MHL2-16D1	462.00
	MHL2-20D1	541.80
	MHL2-25D1	693.00
	MHL2-10D2	546.00
	MHL2-16D2	630.00
MHL2-20D2	756.00	

支点手指	型号	单价
	MHC2-16D	115.50
	MHC2-20D	157.50
	MHC2-25D	199.50

支点手指	型号	单价
	MHC2-16S	115.50
	MHC2-20S	157.50
	MHC2-25S	199.50

摆动气缸	型号	单价
	标准型 MSQB-10A	273.00
	标准型 MSQB-20A	315.00
	标准型 MSQB-30A	378.00
	标准型 MSQB-50A	588.00
	高精密型 MSQA-10A	336.00
	高精密型 MSQA-20A	378.00
	高精密型 MSQA-30A	441.00
	高精密型 MSQA-50A	651.00

摆动气缸	型号	单价
	标准型 MSQB-10R	399.00
	标准型 MSQB-20R	483.00
	标准型 MSQB-30R	546.00
	标准型 MSQB-50R	598.00
	高精密型 MSQA-10R	462.00
	高精密型 MSQA-20R	546.00
	高精密型 MSQA-30R	609.00
	高精密型 MSQA-50R	861.00

注：1、以上报价不含税不含运费，含税加 13%。

2、我司产品均保用一年，保修期内可免费维修，客户使用不当酌情收取维修费用！



辅材



## 辅助元件

亚德客型接头 (蓝色、黑色、白色释放环)

SMC 型接头、铜接头、不锈钢接头、旋转接头

G 螺纹接头 (免生料带)、消声器、PU 气管、弹簧管、尼龙管、吹尘枪

磁性开关、冷风枪、缓冲器、气动锤、气动震动器



金角兽  
JIN JIAO SHOU  
4008-270-668

# CONTENTS



































## 目录



# 金角獸

JIN JIAO SHOU

☎ 4008-270-668

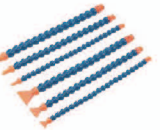
					
56 蓝色快速接头	57 黑色快速接头	57 白色快速接头	59 G 螺纹接头	59 旋转接头	60 PU 气管 (白盘)
					
60 PU 气管 (黄盘)	61 PU 弹簧管	61 PA 系列尼龙管	62 气鼓	62 C 式快拧接头	63 铜镍快拧接头
					
65 铜镍卡套接头	66 铜宝塔接头	68 铜螺纹接头	70 不锈钢快插头	75 不锈钢消声器	76 不锈钢卡套接头
					
77 不锈钢快拧接头	79 铁接头	79 消声器	80 球阀	82 针型阀	82 安全阀
					
83 SMC 型接头	87 磁性开关	88 数显压力开关	89 气动震动器	90 缓冲器	91 真空发生器
					
91 真空过滤器	91 气动缓冲敲击锤	91 TC 冷风枪	92 吹尘枪	92 膜片式压力开关	92 冷却管



蓝色快速接头

DA



型号	名称 单价	XPC	XPCF	XPL	XPB	XPD	XPX	XSL
		螺纹直通	内螺纹直通	L 型二通	T 正型三通	T 侧三通	Y 型三通	L 型节流
4-M5		0.74	1.18	0.86	1.18	1.18	1.18	2.70
4-01		0.82	1.18	0.98	1.38	1.38	1.38	3.30
4-02		1.30	2.20	1.32	1.78	1.78	1.78	5.00
4-03		1.76	-	1.90	-	-	-	-
6-M5		0.82	1.12	1.06	1.56	1.56	1.56	2.70
6-01		0.80	1.12	1.18	1.56	1.56	1.56	3.30
6-02		1.06	2.40	1.32	1.80	1.80	1.80	5.00
6-03		1.66	2.50	1.70	2.20	2.20	2.20	8.90
6-04		3.00	3.50	2.80	3.20	3.20	3.20	12.00
8-01		0.96	1.52	1.38	2.00	2.00	2.00	3.30
8-02		0.96	2.30	1.42	2.00	2.00	2.00	5.00
8-03		1.56	2.40	1.72	2.40	2.40	2.40	8.90
8-04		2.80	3.50	2.96	3.60	3.60	3.60	12.00
10-01		1.42	2.50	1.86	2.80	2.80	2.80	3.80
10-02		1.42	2.50	2.18	3.20	3.20	3.20	5.20
10-03		1.66	2.70	2.36	3.20	3.20	3.20	9.00
10-04		2.50	3.70	2.94	4.00	4.00	4.00	12.10
12-01		1.86	3.54	2.86	3.80	3.80	3.80	-
12-02		2.14	4.00	2.74	3.80	3.80	3.80	5.30
12-03		2.00	4.00	2.74	3.80	3.80	3.80	9.20
12-04		2.48	4.40	2.92	3.80	3.80	3.80	12.10
14-04		4.00	6.00	5.00	6.00	6.00	-	-
16-03		4.00	6.00	5.00	6.00	6.00	-	16.50
16-04		4.00	6.00	5.00	6.00	6.00	-	16.50

DA



型号	名称 单价	XLSA	XPU	XPV	XPY	XPE	XPM	XPZA	XPK	XHVFF
		管道型	直通	L 型二通	Y 型三通	T 型三通	隔板直通	十字四通	五通	手阀
4		3.20	0.52	0.52	0.72	0.72	2.00	1.00	1.20	6.00
6		3.80	0.48	0.54	0.76	0.76	2.30	1.10	1.46	6.50
8		4.80	0.48	0.56	0.80	0.76	2.80	1.30	1.90	7.80
10		8.40	0.76	0.82	1.20	1.16	4.50	1.94	2.60	9.50
12		12.80	0.90	0.98	1.50	1.46	5.50	2.40	3.10	11.00
14		-	1.80	2.00	-	2.80	-	-	-	-
16		-	1.80	2.00	3.20	2.80	-	-	-	-

蓝色快速接头

DA

型号	名称 单价	6-4	8-6	10-8	12-10	8-4	10-6	12-8	16-12
XPG	直通变径	0.56	0.58	0.72	0.94	0.63	0.86	1.04	2.90
XPWY		0.90	0.94	1.40	1.90	0.94	1.40	1.90	-
XPEG		0.80	0.94	1.36	1.80	0.92	1.30	1.70	3.20
XPKG		1.20	1.70	2.20	2.60	1.60	1.80	2.20	-

黑色 / 白色快速接头

高性价比  
有优势

DA

型号	名称 单价	XPC 螺纹直通	XPCF 内螺纹直通	XPL L型二通	XPB T正型三通	XPD T侧三通	XPX Y型三通	XSL L型节流
4-M5		0.96	1.36	1.20	1.90	1.90	1.90	3.60
4-01		0.96	1.36	1.40	1.90	1.90	1.90	4.00
4-02		1.40	2.24	1.68	2.24	2.24	2.24	5.80
4-03		2.20	3.16	2.60	2.24	2.24	2.24	10.00
6-M5		0.96	1.36	1.40	1.96	1.96	1.96	3.60
6-01		0.96	1.36	1.56	1.96	1.96	1.96	4.00
6-02		1.20	2.40	1.70	2.30	2.30	2.30	5.80
6-03		2.20	2.78	2.40	2.74	2.74	2.74	10.00
6-04		4.00	4.30	3.70	3.92	3.92	3.92	13.00
8-01		1.18	1.98	1.70	2.40	2.40	2.40	4.00
8-02		1.18	2.42	1.70	2.40	2.40	2.40	5.80
8-03		2.00	2.80	2.40	2.86	2.86	2.86	10.00
8-04		3.80	4.30	3.70	3.92	3.92	3.92	13.00
10-01		1.90	2.90	2.80	3.56	3.56	3.56	5.00
10-02		1.90	2.80	3.00	3.56	3.56	3.56	7.00
10-03		2.20	3.00	3.00	3.56	3.56	3.56	10.00
10-04		3.40	4.20	3.90	4.88	4.88	4.88	14.00
12-01		2.60	4.20	3.70	4.88	4.88	4.88	-
12-02		2.80	4.20	3.80	4.88	4.88	4.88	7.00
12-03		3.00	4.20	3.80	4.88	4.88	4.88	10.00
12-04		3.40	4.64	4.00	4.88	4.88	4.88	14.00
14-04		5.00	8.00	7.00	8.00	8.00	8.00	-
16-03		5.00	8.00	7.00	8.00	8.00	8.00	-
16-04		5.00	8.00	7.00	8.00	8.00	8.00	20.00

黑色 / 白色快速接头

高性价比  
有优势



型号	名称 单价	XLSA 管道型	XPU 直通	XPV L 型二通	XPY Y 型三通	XPE T 型三通	XPM 隔板直通	XPZA 十字四通	XPK 五通	XHVFF 手阀
4		6.00	0.78	0.78	1.10	1.10	2.40	1.68	2.36	8.00
6		6.50	0.80	0.80	1.16	1.16	2.80	1.68	2.36	8.00
8		7.50	0.80	0.80	1.18	1.18	3.40	1.96	2.76	10.00
10		10.80	1.10	1.10	1.70	1.70	5.80	3.14	4.72	12.00
12		14.00	1.20	1.20	2.00	2.00	7.60	3.14	5.80	14.00
14		-	3.00	3.00	5.00	5.00	-	-	-	-
16		-	3.00	3.00	5.00	5.00	-	-	-	-



型号	名称 单价	6-4	8-6	10-8	12-10	8-4	10-6	12-8	16-12
XPG 直通变径		0.92	0.95	1.20	1.60	1.00	1.28	1.68	5.00
XPWY		1.20	1.36	1.88	2.60	1.50	2.10	2.70	7.00
XPEG		1.20	1.36	1.88	2.60	1.50	2.10	2.70	7.00
XPKG		2.80	3.30	4.40	5.80	4.60	5.20	5.80	-

G 螺纹接头

带密封圈，免生料带  
高性价比 有优势



DA

型号	名称 单价	HPC-G	HPL-G	HSL-G	HPB-G	HPD-G	HPX-G
		G 螺纹直通	L 型三通	L 型节流	T 正型三通	T 侧三通	Y 型三通
4-M5G		0.96	1.20	3.60	1.90	1.90	1.90
4-01G		1.20	1.46	4.20	2.20	2.20	2.20
4-02G		1.70	2.20	6.20	3.00	3.00	3.00
4-03G		-	-	-	-	-	-
6-M5G		0.96	1.40	3.60	1.96	1.96	1.96
6-01G		1.30	1.64	4.20	2.40	2.40	2.40
6-02G		1.50	2.00	5.90	3.00	3.00	3.00
6-03G		2.60	3.20	10.20	3.60	3.60	3.60
6-04G		4.40	4.00	13.20	5.00	5.00	5.00
8-01G		1.50	2.00	4.20	3.00	3.00	3.00
8-02G		1.50	2.00	5.90	3.00	3.00	3.00
8-03G		2.40	3.00	10.20	3.60	3.60	3.60
8-04G		4.00	4.00	13.20	5.60	5.60	5.60
10-01G		2.10	3.00	5.20	3.60	3.60	3.60
10-02G		2.20	3.20	7.20	3.60	3.60	3.60
10-03G		2.80	3.40	10.20	4.00	4.00	4.00
10-04G		4.00	4.60	14.20	5.60	5.60	5.60
12-01G		3.20	4.00	-	4.00	4.00	4.00
12-02G		3.20	4.00	7.20	5.60	5.60	5.60
12-03G		3.20	4.00	10.20	5.60	5.60	5.60
12-04G		4.00	4.60	14.20	5.60	5.60	5.60

旋转接头

高性价比  
有优势



DA

HRL / HRC 高速旋转接头	名称 单价	6-M5G	6-01G	6-02G	6-03G	6-04G	8-01G	8-02G	8-03G	8-04G
	-	18.00	18.00	18.00	22.00	30.00	18.00	18.00	22.00	30.00
	-	18.00	18.00	18.00	22.00	30.00	18.00	18.00	22.00	30.00



DA

HRL / HRC 高速旋转接头	名称 单价	10-01G	10-02G	10-03G	10-04G	12-01G	12-02G	12-03G	12-04G
	-	24.00	24.00	30.00	32.00	24.00	24.00	30.00	32.00
	-	24.00	24.00	30.00	32.00	24.00	24.00	30.00	32.00

PU 气管

PU 气管 (白盘)	规格型号	颜色	米数 (M)	单价	备注
<p>PU80</p>	PU4X2.5	红蓝白黑	180	86.00	12 卷 / 箱
	PU6X4	红蓝白黑	160	136.00	7 卷 / 箱
	PU8X5	红蓝白黑	80	108.00	8 卷 / 箱
	PU10X6.5	红蓝白黑	80	164.00	5 卷 / 箱
	PU12X8	红蓝白黑	80	226.00	4 卷 / 箱
	PU14X10	红蓝白黑	80	320.00	2 卷 / 箱
	PU16X12	红蓝白黑	80	376.00	2 卷 / 箱
	PU18X14	红蓝白黑	50	490.00	2 卷 / 箱
	PU20X16	红蓝白黑	50	536.00	2 卷 / 箱

DA

PE 气管 (黄盘)	规格型号	颜色	米数 (M)	单价	备注
<p>PU80</p>	PE4X2.5	红蓝白黑	180	60.00	12 卷 / 箱
	PE6X4	红蓝白黑	180	80.00	8 卷 / 箱
	PE8X5	红蓝白黑	80	60.00	10 卷 / 箱
	PE10X6.5	红蓝白黑	80	110.00	6 卷 / 箱
	PE12X8	红蓝白黑	80	130.00	4 卷 / 箱
	PE16X12	红蓝白黑	80	220.00	2 卷 / 箱

PU80

DA

PU 气管 (黄盘)	规格型号	颜色	米数 (M)	单价	备注
<p>PU90 纯料</p>	PU4X2.5	红蓝白黑	180	90.00	12 卷 / 箱
	PU6X4	红蓝白黑	180	158.00	7 卷 / 箱
	PU8X5	红蓝白黑	90	136.00	7 卷 / 箱
	PU10X6.5	红蓝白黑	90	204.00	5 卷 / 箱
	PU12X8	红蓝白黑	90	286.00	4 卷 / 箱
	PU14X10	红蓝白黑	90	390.00	2 卷 / 箱
	PU16X12	红蓝白黑	90	452.00	2 卷 / 箱
	PU18X14	红蓝白黑	50	498.00	2 卷 / 箱
	PU20X16	红蓝白黑	50	542.00	2 卷 / 箱

PU90 纯料

DA

PU 气管 (黄盘)	规格型号	颜色	米数 (M)	单价	备注
	PU4X2.5	红蓝白黑	200	96.00	12 卷 / 箱
	PU6X4	红蓝白黑	200	176.00	7 卷 / 箱
	PU8X5	红蓝白黑	100	144.00	7 卷 / 箱
	PU10X6.5	红蓝白黑	100	214.00	5 卷 / 箱
	PU12X8	红蓝白黑	100	304.00	4 卷 / 箱
	PU14X10	红蓝白黑	100	420.00	2 卷 / 箱
	PU16X12	红蓝白黑	100	480.00	2 卷 / 箱

PU100 足米纯料

DA

PU 弹簧管 (不含接头)	型号	长度	单价	型号	长度	单价
	PU6x4	3 米	5.00	PU10x6.5	6 米	18.00
	PU6x4	6 米	8.00	PU10x6.5	9 米	26.00
	PU6x4	9 米	12.00	PU10x6.5	12 米	38.00
	PU6x4	12 米	16.00	PU10x6.5	15 米	48.00
	PU6x4	15 米	20.00	PU12x8	3 米	12.00
	PU8x5	3 米	7.00	PU12x8	6 米	24.00
	PU8x5	6 米	12.00	PU12x8	9 米	36.00
	PU8x5	9 米	18.00	PU12x8	12 米	48.00
	PU8x5	12 米	24.00	PU12x8	15 米	60.00
	PU8x5	15 米	30.00	PU14x10	每米	6.00
	PU10x6.5	3 米	10.00	PU16x12	每米	8.00

纯料生产, 高温定型

DA

PA 系列尼龙管	型号	米数	单价
	PA 4*0.75	200	208.00
	PA 6*1	100	140.00
	PA 8*1	100	186.00
	PA 10*1	100	278.00
	PA 10*1.5	100	346.00
	PA 12*1	100	346.00
	PA 12*1.5	100	416.00
	PA 14*1.5	50	416.00
	PA 16*1.5	50	462.00

DA

气鼓	型号	单价
	8X5-10M	232.00
	8X5-12M	252.00
	8X5-15M	274.00
	8X5-20M	304.00
	8X5-25M	346.00
	10X6.5-10M	274.00

DA

气鼓	型号	单价
	10X6.5-12M	284.00
	10X6.5-15M	304.00
	10X6.5-20M	346.00
	12X8-10M	316.00
	12X8-12M	336.00
	12X8-15M	378.00

DA

C 式快拧接头

高性价比

SP	型号	单价
	SP-10	2.78
	SP-20	2.44
	SP-30	2.96
	SP-40	3.30

PP	型号	单价
	PP-10	1.04
	PP-20	0.70
	PP-30	1.04
	PP-40	1.74

SM	型号	单价
	SM-20	2.44
	SM-30	2.96
	SM-40	2.96

PM	型号	单价
	PM-20	0.52
	PM-30	1.22
	PM-40	1.74

SH	型号	单价
	SH-20	2.44
	SH-30	2.96
	SH-40	3.48

PH	型号	单价
	PH-20	0.70
	PH-30	1.04
	PH-40	1.56

SF	型号	单价
	SF-20	2.44
	SF-30	3.12
	SF-40	3.66

PF	型号	单价
	PF-20	0.70
	PF-30	1.40
	PF-40	1.92

SMV	型号	单价
	SMV	8.34
	SMV (外丝)	10.44

SMY	型号	单价
	SMY	10.08
	SMY(外丝)	12.16

SML (带接头)	型号	单价
	SML-2	10.44
	SML-3	15.64
	SML-4	20.86
	SML-5	26.08
	SML-6	31.30
	SML-7	36.50
	SML-8	41.72
	SML-9	46.94
	SML-10	52.16

ML	型号	(20*20)	(30*30)	(40*40)
	ML-2	4.52	17.38	26.08
	ML-3	6.78	26.08	39.12
	ML-4	9.04	34.76	52.16
	ML-5	11.3	43.46	65.2
	ML-6	13.56	52.16	78.22
	ML-7	15.82	60.84	91.26
	ML-8	18.08	69.54	104.3
	ML-9	20.34	78.22	117.34
	ML-10	22.6	86.92	130.38

自锁接头

自锁接头	型号	单价
	SP-10	-
	SP-20	8.30
	SP-30	9.02
	SP-40	9.38
	SM-20	8.30
	SM-30	9.02
	SM-40	9.38
	SH-20	8.30
	SH-30	9.02
	SH-40	9.38
	SF-20	8.30
	SF-30	9.02
	SF-40	9.38
	二通 SMV	22.56
	SMV (外丝)	26.16
	SP10+PP10	-
SP20+PP20	9.56	
SP30+PP30	10.46	
SP40+PP40	11.36	
SM20+PM20	9.56	
SM30+PM30	10.46	
SM40+PM40	11.36	

DB

铜镀镍快拧接头

快拧螺纹直通	型号	单价
	4-M5	1.22
	4-M6	1.44
	4-01	1.22
	4-02	1.88
	6-M5	1.22
	6-M6	1.22
	6-01	1.10
	6-02	1.32
	6-03	2.20
	6-04	2.76
	8-01	1.38
	8-02	1.50
	8-03	2.20
	8-04	2.76
	10-01	1.82
	10-02	1.82
	10-03	2.34
	10-04	2.98
	12-01	2.64
	12-02	2.64
	12-03	3.08
	12-04	3.30
	14-02	5.62
	14-03	5.62
14-04	5.62	
16-02	5.72	
16-03	5.50	
16-04	5.50	
16-06	8.80	

DC

自锁接头	型号	单价
	PP-10	-
	PP-20	1.26
	PP-30	1.44
	PP-40	1.98
	PM-20	1.26
	PM-30	1.44
	PM-40	1.98
	PH-20	1.26
	PH-30	1.44
	PH-40	1.98
	PF-20	1.26
	PF-30	1.44
	PF-40	1.98
	三通 SMY	31.58
	SMY (外丝)	35.18
	SH20+PH20	9.56
	SH30+PH30	10.46
	SH40+PH40	11.36
	SF20+PF20	9.56
SF30+PF30	10.46	
SF40+PF40	11.36	

DB

快拧内丝直通	型号	单价
	4-01	1.94
	4-02	2.86
	4-04	3.30
	6-01	1.44
	6-02	1.88
	6-03	3.30
	6-04	3.96
	8-01	1.98
	8-02	2.20
	8-03	3.08
	8-04	3.96
	10-01	3.30
	10-02	2.20
	10-03	3.20
	10-04	3.96
	12-02	2.76
	12-03	3.52
	12-04	4.62
16-04	5.94	
16-06	10.56	

DC



铜镀镍快拧接头

快拧内丝直通	型号	单价
	4-14*1.5	3.30
	6-14*1.5	2.64
	6-20*1.5	5.50
	8-15*1.5	2.64
	8-20*1.5	5.50
	10-14*1.5	3.30
	10-20*1.5	6.16
	12-12*1	4.84
DC	12-14*1.5	3.30
	12-20*1.5	6.60
快拧管道直通	型号	单价
	φ4	2.20
	φ6	1.76
	φ8	2.32
	φ10	3.08
	φ12	4.18
DC	φ14	7.70
	φ16	8.80
快拧变径	型号	单价
	φ6-4	3.20
	φ6-8	2.76
	φ8-10	3.52
	φ8-12	5.18
	φ10-12	5.18
	φ10-6	5.18
DC	φ14-10	9.90
	φ16-12	9.90
快拧弯通	型号	单价
	4-M5	2.64
	4-01	2.64
	4-02	3.96
	6-M5	2.64
	6-01	1.88
	6-02	2.86
	6-03	3.74
	6-04	5.46
	8-01	2.42
	8-02	3.08
	8-03	4.40
	8-04	6.38
	10-01	3.52
	10-02	3.86
	10-03	5.06
	10-04	6.60
	12-01	5.18
DC	12-02	5.18
	12-03	5.72
	12-04	7.04
	16-04	14.30

铜镀镍快拧接头

快拧直角弯通	型号	单价
	φ6	2.98
	φ8	3.96
	φ10	5.62
	φ12	7.04
	φ14	14.30
	φ16	14.52
快拧三通	型号	单价
	φ4	3.70
	φ6	3.64
	φ8	4.76
	φ10	6.60
	φ12	8.58
DC	φ14	17.60
	φ16	18.70
快拧四通	型号	单价
	φ6	7.04
	φ8	7.70
	φ10	11.66
	φ12	13.86
快拧三通变径	型号	单价
	φ6-4-6	4.62
	φ8-6-8	5.94
	φ10-8-10	7.70
	φ12-8-12	10.34
	φ12-10-12	10.34
	φ6-8-6	5.94
	φ8-10-8	7.70
	φ10-12-10	10.34
	φ8-12-8	10.34
	φ16-12-16	22.00

铜镀镍快拧接头

快拧串板	型号	单价
	φ4	3.52
	φ6	3.52
	φ8	4.40
	φ10	5.94
	φ12	7.04

DC

快拧弯头 TF 型	型号	单价
	6-01	2.86
	6-02	3.20
	6-03	4.84
	6-04	6.38
	8-01	3.08
	8-02	3.20
	8-03	5.06
	8-04	6.38
	10-01	3.74
	10-02	3.92
	10-03	5.50

DC

快拧三通 TF 型	型号	单价
	φ6	4.62
	φ8	5.50
	φ10	6.82
	φ12	9.24

DC

快拧正三通 TF 型	型号	单价
	4-01	4.40
	6-01	4.40
	6-02	5.50
	6-03	7.92
	6-04	8.80
	8-01	5.50
	8-02	5.50
	8-03	8.36
	8-04	10.34
	10-01	6.60
	10-02	6.60
	10-03	8.36
	10-04	10.56
	12-02	9.24
	12-03	9.90
	12-04	10.56
14-04	17.60	
16-04	18.70	

DC

铜镀镍卡套接头

卡套螺纹直通	型号	单价
	4-M5	1.44
	4-M6	1.44
	4-01	1.32
	4-02	1.88
	6-M5	1.44
	6-M6	1.44
	6-01	1.32
	6-02	1.54
	6-03	2.20
	6-04	2.82
	8-01	1.54
	8-02	1.76
	8-03	2.20
	8-04	2.86
	10-01	1.98
	10-02	1.98
	10-03	2.76
	10-04	3.30
	12-01	2.82
	12-02	2.82
	12-03	2.98
	12-04	3.52
	14-02	5.84
	14-03	5.84
14-04	5.84	
16-03	5.84	
16-04	5.84	

DC

卡套螺纹弯通	型号	单价
	4-01	2.64
	6-M5	2.64
	6-01	2.42
	6-02	3.30
	6-03	4.40
	6-04	5.94
	8-01	2.86
	8-02	3.30
	8-03	4.62
	8-04	6.16
	10-01	3.64
	10-02	3.86
	10-03	5.06
	10-04	6.60
	12-01	5.28
	12-02	5.28
12-03	6.16	
12-04	8.58	

DC

### 铜镀镍卡套接头

卡套直角	型号	单价
	φ6	2.86
	φ8	4.08
	φ10	5.94
	φ12	7.48

卡套内丝直通	型号	单价
	4-02	2.86
	6-01	2.10
	6-02	3.30
	6-03	3.96
	6-04	4.84
	8-01	2.20
	8-02	3.30
	8-03	3.96
	8-04	5.28
	10-02	3.30
	10-03	4.62
	10-04	5.50
	12-02	4.18
	12-03	4.84
	12-04	6.16
	6-14*1.5	3.30
	6-20*1.5	5.72
	8-14*1.5	3.30
	8-20*1.5	5.72
	DC 10-14*1.5	3.96
10-20*1.5	5.72	

卡套直通	型号	单价
	φ4	2.20
	φ6	1.98
	φ8	2.64
	φ10	3.52
	φ12	4.18
	DC φ14	8.36
	φ16	9.46

卡套变径	型号	单价
	φ6-8	2.76
	φ8-10	3.64
	φ8-12	5.50
	DC φ10-12	5.50

铜镀镍单向阀	型号	单价
	1/8	3.74
	1/4	4.84
	3/8	8.80
	DC 1/2	13.64

### 铜镀镍卡套接头

卡套串板	型号	单价
	φ6	3.74
	φ8	5.06
	φ10	6.60
	DC φ12	8.36

卡套三通	型号	单价
	φ4	3.74
	φ6	3.74
	φ8	4.74
	φ10	6.60
	φ12	9.02
	DC φ16	19.80

### 铜宝塔接头

宝塔二通	型号	单价
	φ6	0.70
	φ8	0.88
	φ10	1.16
	φ12	1.48
DC		

宝塔外螺弯通 PL	型号	单价
	6-01	2.64
	6-02	2.86
	6-03	3.96
	6-04	4.62
	8-01	2.64
	8-02	2.86
	8-03	3.74
	8-04	4.18
	10-01	3.08
	10-02	3.08
	10-03	3.86
	10-04	4.40
	12-02	4.40
	12-03	4.84
	12-04	5.06
	14-03	5.50
14-04	5.50	
DC 16-04	7.70	

铜宝塔接头

宝塔外丝直通 PC	型号	单价
	6-01	0.74
	6-02	0.90
	6-03	1.56
	6-04	1.78
	8-01	0.84
	8-02	1.04
	8-03	1.56
	8-04	1.78
	8-06	3.96
	10-01	0.92
	10-02	1.04
	10-03	1.56
	10-04	1.78
	10-06	3.96
	12-01	1.10
	12-02	1.32
	12-03	1.88
	12-04	2.20
	12-06	3.96
	14-02	2.04
	14-03	2.10
	14-04	2.60
	16-03	2.10
	16-04	2.78
	16-06	4.62
	19-04	3.04
	19-06	4.84
	19-G1	8.36
	25-06	5.72
	25-G1	8.36
DC	40-40	14.30



DC

加厚外螺直通宝塔 PC	型号	单价
	8-01	1.76
	8-02	1.98
	8-03	2.86
	8-04	3.30
	10-02	1.98
	10-03	2.86
	10-04	3.30
	12-02	2.64
	12-03	3.30
	12-04	3.52
	14-04	3.52
	16-04	3.96
	19-04	3.96
	19-06	6.16
DC	25-G1	10.56



DC

铜宝塔接头

宝塔三通	型号	单价
	φ6	2.16
	φ8	2.16
	φ10	2.16
DC	φ12	3.30



DC

宝塔内丝直通	型号	单价
	6-01	1.10
	6-02	1.28
	6-03	2.10
	6-04	2.32
	8-01	1.10
	8-02	1.32
	8-03	2.10
	8-04	2.32
	10-01	1.32
	10-02	1.44
	10-03	2.10
	10-04	2.32
	12-02	2.32
	12-03	2.54
	12-04	2.98
	12-06	5.50
	14-04	3.52
	16-04	3.52
	19-04	3.74
DC	19-06	7.04



DC

宝塔三通	型号	单价
	φ6	2.16
	φ8	2.16
	φ10	2.16
	φ12	3.30
	φ14	7.70
	φ16	7.70
DC	φ19	14.30



DC

加厚宝塔三通	型号	单价
	φ6	3.30
	φ8	3.30
	φ10	3.30
DC	φ12	4.84



DC

### 铜宝塔接头

宝塔四通	型号	单价
	φ6	3.74
	φ8	3.64
	φ10	3.64
	φ12	4.84

DC

### 铜螺纹接头

铜对丝	型号	单价
	1/8	0.70
	1/4	1.00
	3/8	1.66
	1/2	2.34
	3/4	4.18
	G1	7.26
	1/8-1/4	1.00
	1/8-3/8	1.54
	1/4-3/8	1.66
	1/4-1/2	1.88
	1/2-3/8	1.98
	1/2-3/4	4.18
	1/4-3/4	5.06
	3/8-3/4	5.50
	4-G1	6.60
	6-G1	6.60
1-1/4	15.84	
1-1/2	23.76	

DC

加厚对丝	型号	单价
	1/4	1.98
	3/8	2.86
	1/2	3.96
	3/4	5.06
	G1	8.36
	1-2	1.98
	2-3	2.64
	2-4	3.30
	3-4	3.30
	4-6	5.06
4-G1	8.58	
6-G1	8.58	

DC

### 铜螺纹接头

内接	型号	单价
	1/8	1.10
	1/4	1.54
	3/8	2.10
	1/2	2.98
	3/4	5.94
	G1	9.46

DC

加长对丝 60mm	型号	单价
	1/8	4.84
	1/4	4.84
	3/8	6.60
	1/2	8.36
	2-3	6.60
	2-4	8.36
3-4	8.36	

DC

内外接头	型号	单价
	1/8	1.00
	1/4	1.44
	3/8	1.98
	1/2	2.98
	3/4	4.84
	G1	9.90
	1/8-1/4	1.32
	1/4-3/8	1.98
	1/4-1/2	2.64
	1/2-3/8	2.64
	1/2-3/4	4.62
	6-G1	9.90
	4-G1	9.24

DC

压力表接头	型号	单价
	外 1/4- 内 14×1.5	1.98
	外 1/2- 内 14×1.5	2.20
	外 1/2- 内 20×1.5	3.08
	加厚外 1/4- 内 14×1.5	2.64

DC

内外弯头	型号	单价
	1/8	2.20
	1/4	3.08
	3/8	5.06
	1/2	5.28
	3/4	9.90

DC

铜螺纹接头

外丝弯头	型号	单价
	1/8	2.20
	1/4	3.08
	3/8	3.64
	1/2	5.28

内丝弯头	型号	单价
	1/8	2.20
	1/4	3.08
	3/8	4.08
	1/2	4.62
	3/4	8.36

内丝三通	型号	单价
	1/8	3.02
	1/4	4.08
	3/8	5.50
	1/2	5.72
	3/4	10.56
	G1	17.16

外丝三通	型号	单价
	1/8	3.02
	1/4	4.08
	3/8	5.06
	1/2	6.16

内丝四通	型号	单价
	1/4	7.26
	1/2	7.92

铜堵头	型号	单价
	1/8	0.56
	1/4	0.78
	3/8	1.44
	1/2	2.10
	3/4	4.40
	G1	8.36

铜螺纹接头

补芯	型号	单价
	M5-1/8	1.00
	1/8-1/4	0.74
	1/8-3/8	1.54
	1/4-3/8	1.00
	1/4-1/2	2.10
	3/8-1/2	1.32
	1/2-3/4	2.20
	1/2-G1	4.84
	3/4-G1	3.96
	1/4-3/4	4.62
	3/8-3/4	4.84

外六角堵头	型号	单价
	1/8	1.00
	1/4	1.10
	3/8	1.50
	1/2	2.10

加厚补芯	型号	单价
	4:6	2.86
	4:G1	6.16
	6:G1	5.06

内卡直通	型号	单价
	4-1/8	1.44
	4-6×1	1.44
	4-8×1	1.44
	4-10×1	1.44
	6-01	1.66
	6-1×6	1.66
	6-1×8	1.66
	6-1×10	1.66
	6-02	3.30
	8-01	3.30
	8-02	3.30

铜螺纹接头

油令头 (卡套接头)	型号	单价
	φ4	0.14
	φ6	0.16
	φ8	0.18
	φ10	0.20
	φ12	0.34
	φ14	0.56
	φ16	0.66
	φ18	1.00

DC

内卡弯通	型号	单价
	4-1/8	2.20
	4-10×1	2.20
	4-8×1	2.20
	4-6×1	2.20
	6-1/8	2.86
	6-6×1	2.86
	6-8×1	2.86
	6-10×1	2.86

DC

内卡三通	型号	单价
	φ4	5.72
	φ6	6.38

DC

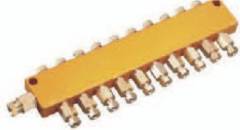
油排	型号	单价
	2 位	8.80
	4 位 -10 位	每位 4.18

DC

不锈钢快插接头

直通终端 BKC-PC	规格	304	316
	4-R01	6.72	9.12
	4-R02	6.72	9.12
	6-R01	6.72	9.12
	6-R02	6.72	9.12
	6-R03	8.16	10.56
	6-R04	10.24	12.64
	8-R01	7.52	9.6
	8-R02	7.52	9.6
	8-R03	8.32	10.72
	8-R04	9.6	12.64
	8-R06	13.6	16
	10-R01	8.8	11.2
	10-R02	8.8	11.2
	10-R03	8.8	11.2
	10-R04	10.24	12.64
	10-R06	13.6	16
	12-R01	9.12	11.52
	12-R02	9.12	11.52
	12-R03	9.12	11.52
	12-R04	10.24	12.64
	12-R06	13.6	16
	14-R02	11.68	14.08
	14-R03	11.68	14.08
	14-R04	11.68	14.08
14-R06	13.6	16	
16-R02	12	14.4	
16-R03	12	14.4	
16-R04	10.88	14.4	
16-R06	13.6	16	
3-M3	12	14.4	
3-M5	12	14.4	
4-M5	8	9.6	
6-M5	8	9.6	

DF

不锈钢快插接头

360度直角外螺纹 BKC-PL	规格	304	316
	4-R01	18.6	18.88
	4-R02	18.6	18.88
	6-R01	18.6	18.88
	6-R02	18.6	18.88
	6-R03	18.6	19.84
	6-R04	21	20.96
	8-R01	20	19.84
	8-R02	20	19.84
	8-R03	20.6	20.96
	8-R04	22	21.76
	8-R06	26	24.96
	10-R01	23.6	23.04
	10-R02	23.6	23.04
	10-R03	23.6	23.04
	10-R04	25.2	24.32
	10-R06	29.2	27.52
	12-R01	26	24.16
	12-R02	26	24.96
	12-R03	26	24.16
	12-R04	28.4	26.88
	12-R06	32.4	27.52
	14-R02	33	27.52
	14-R03	33	27.52
	14-R04	33	27.52
	14-R06	36	30.4
	16-R02	33.6	28.16
	16-R03	33.6	28.16
	16-R04	33.6	28.16
	16-R06	36	30.4
	3-M3	30	28.16
	3-M5	30	28.16
	4-M5	18.6	18.88
	6-M5	18.6	18.88



DF

直通终端 BKC-PC-G	规格	304	316
	4-G01	8	10.4
	4-G02	8	10.4
	6-G01	8	10.4
	6-G02	8	10.4
	6-G03	9.44	11.84
	6-G04	11.52	13.92
	8-G01	8.48	10.88
	8-G02	8.48	10.88
	8-G03	9.6	12
	8-G04	11.52	13.92
	8-G06	14.88	17.28
	10-G01	10.08	12.48
	10-G02	10.08	12.48
	10-G03	10.08	12.48
	10-G04	11.52	13.92
	10-G06	14.88	17.28
	12-G01	10.4	12.8
	12-G02	10.4	12.8
	12-G03	10.4	12.8
	12-G04	11.52	13.92
	12-G06	14.88	17.28
	14-G02	12.96	15.36
	14-G03	12.96	15.36
	14-G04	12.96	15.36
	14-G06	14.88	17.28
	16-G02	13.28	15.68
	16-G03	13.28	15.68
	16-G04	13.28	15.68



DF

直通 BKC-PU	规格	304	316
	4	9.12	12.48
	6	9.44	12.8
	8	10.24	13.6
	10	10.88	14.24
	12	11.84	15.2
	14	13.44	16.8
	16	14.24	17.6
	18	19.2	22.4
	20	24	27.2
	3	13.6	16.8



DF



不锈钢快插接头

360度直角外螺纹 BKC-PL-G	规格	304	316
	4-G01	16.32	20.48
	4-G02	16.32	20.48
	6-G01	16.32	20.48
	6-G02	16.32	20.48
	6-G03	17.28	21.44
	6-G04	18.4	22.56
	8-G01	17.28	21.44
	8-G02	17.28	21.44
	8-G03	18.4	22.56
	8-G04	19.2	23.36
	8-G06	22.4	26.56
	10-G01	20.48	24.64
	10-G02	20.48	24.64
	10-G03	20.48	24.64
	10-G04	21.76	25.92
	10-G06	24.96	29.12
	12-G01	21.6	25.76
	12-G02	22.4	26.56
	12-G03	21.6	25.76
	12-G04	24.32	28.48
	12-G06	24.96	29.12
	14-G02	24.96	29.12
	14-G03	24.96	29.12
	14-G04	24.96	29.12
	14-G06	25.6	29.76
	16-G02	25.6	29.76
	16-G03	25.6	29.76
	16-G04	25.6	29.76



DF

弯通 BKC-PV	规格	304	316
	4	15.68	18.88
	6	15.68	18.88
	8	16.8	20
	10	20	23.2
	12	22.4	25.6
	14	24	27.2
	16	32	35.2



DF

Y型三通 BKC-PY	规格	304	316
	4	20.8	27.2
	6	22.4	28.8
	8	24	30.4
	10	27.2	33.6
	12	30.4	36.8
	14	35.2	41.6
	16	51.2	57.6



DF

直通变径 BKC-PG	规格	304	316
	6-4	10.08	12.48
	8-4	12	14.4
	8-6	10.4	12.8
	10-6	11.04	13.44
	10-8	11.04	13.44
	12-6	12	14.4
	12-8	12	14.4
	12-10	12.48	14.88
	14-12	13.92	16.32
	16-12	14.72	17.12
	16-14	16	18.4



DF

Y型变径三通 BKC-PYG	规格	304	316
	6-4	25.6	32
	8-4	27.2	33.6
	8-6	27.2	33.6
	10-6	30.4	36.8
	10-8	30.4	36.8
	12-6	33.6	40
	12-8	33.6	40
	12-10	33.6	40
	16-12	56	62.4



DF

隔板直通 BKC-PM	规格	304	316
	4	13.6	16.8
	6	14.72	17.92
	8	15.36	18.56
	10	17.6	20.8
	12	18.4	21.6
	14	22.4	25.6
	16	24	27.2
	18	25.6	28.8
	20	30.4	33.6
	3	20	23.2



DF

### 不锈钢快插接头

T型三通 BKC-PE	规格	304	316
	4	17.6	20.92
	6	17.6	20.92
	8	20.14	23.34
	10	21.76	24.96
	12	23.86	27.06
	14	23.86	27.38
	16	30.62	33.82

DF

四通 BKC-PX	规格	304	316
	4	30.4	36.8
	6	30.4	36.8
	8	33.6	40
	10	36.8	43.2

DF

三通变径 BKC-PEG	规格	304	316
	6-4	19.2	24
	8-4	21.76	26.56
	8-6	21.76	26.56
	10-6	23.36	28.16
	10-8	23.36	28.16
	12-6	25.6	30.4
	12-8	25.6	30.4
	12-10	25.6	30.4
	14-12	25.6	30.4
	16-12	32	36.8
	16-14	32	36.8

DF

直通内牙 BKC-PCF	规格	304	316
	4-M5	9.76	12.16
	4-G01	9.76	12.16
	4-G02	9.92	12.32
	6-M5	9.92	12.32
	6-G01	9.92	12.32
	6-G02	9.92	12.32
	6-G03	11.36	13.76
	6-G04	13.6	16
	8-G01	9.76	12.16
	8-G02	9.76	12.16
	8-G03	11.52	13.92
	8-G04	13.6	16
	8-G06	19.04	21.44
	10-G01	11.52	13.92
	10-G02	11.68	14.08
	10-G03	12.64	15.04
	10-G04	13.76	16.16
	10-G06	19.04	21.44
	12-G01	11.68	14.08
	12-G02	11.68	14.08
	12-G03	12.64	15.04
	12-G04	13.76	16.16
	12-G06	19.04	21.44
	14-G02	15.84	18.24
14-G03	15.84	18.24	
14-G04	15.84	18.24	
14-G06	19.04	21.44	
16-G02	15.84	18.24	
16-G03	15.84	18.24	
16-G04	15.84	18.24	
16-G06	19.04	21.44	

DF

卡套隔板快插 BKC-PMK	规格	304	316
	4	13.76	16.96
	6	14.4	17.6
	8	15.2	18.4
	10	17.6	20.8
	12	18.4	21.6
	14	22.4	25.6
	16	24	27.2

DF

不锈钢快插接头

单向节流阀 BKC-SLT	规格	304	316
	3-M3	67.52	83.52
	4-M5	47.68	63.68
	4-R01	47.68	63.68
	4-R02	47.68	63.68
	6-M5	47.68	63.68
	6-R01	47.68	63.68
	6-R02	51.2	67.2
	6-R03	51.2	67.2
	6-R04	51.2	67.2
	8-R01	51.2	67.2
	8-R02	51.2	67.2
	8-R03	51.2	67.2
	8-R04	52.8	68.8
	10-R01	52.8	68.8
	10-R02	52.8	68.8
	10-R03	52.8	68.8
	10-R04	54.4	70.4
	12-R01	54.4	70.4
	12-R02	54.4	70.4
	12-R03	54.4	70.4
	12-R04	54.4	70.4
	12-R06	56	72
	14-R02	56	72
	14-R03	56	72
	14-R04	56	72
	14-R06	56	72
	16-R02	64	80
	16-R03	64	80
	16-R04	64	80
	16-R06	64	64



DF

单向节流阀 BKC-SLT-G	规格	304	316
	4-G01	52.48	68.48
	4-G02	52.48	68.48
	6-G01	52.48	68.48
	6-G02	56	72
	6-G03	56	72
	6-G04	56	72
	8-G01	56	72
	8-G02	56	72
	8-G03	56	72
	8-G04	57.6	73.6
	8-G06	59.2	75.2
	10-G01	57.6	73.6
	10-G02	57.6	73.6
	10-G03	57.6	73.6
	10-G04	59.2	75.2
	10-G06	60.8	76.8
	12-G01	59.2	75.2
	12-G02	59.2	75.2
	12-G03	59.2	75.2
	12-G04	59.2	75.2
	12-G06	60.8	76.8
	14-G02	60.8	76.8
	14-G03	60.8	76.8
	14-G04	60.8	76.8
	14-G06	60.8	76.8
	16-G02	68.8	84.8
	16-G03	68.8	84.8
	16-G04	68.8	84.8
	16-G06	68.8	84.8



DF

### 不锈钢快插接头

单向节流阀 BKC-SL	规格	304	316
	4-M5	52	68
	4-R01	52	68
	4-R02	52	68
	6-M5	52	68
	6-R01	52	68
	6-R02	52	68
	6-R03	58.4	74.4
	6-R04	58.4	74.4
	8-R01	53.6	69.6
	8-R02	53.6	69.6
	8-R03	58.4	74.4
	8-R04	58.4	74.4
	10-R01	52	68
	10-R02	58.4	74.4
	10-R03	58.4	74.4
	10-R04	58.4	74.4
	12-R02	52	68
	12-R03	58.4	74.4
	12-R04	58.4	74.4



DF

### 不锈钢消声器

宝塔消声器 PBSL-R	规格	304	316
	M5	8.8	12.32
	1/8	7.4	12.32
	1/4	8.8	12.32
	3/8	10.92	21.12
	1/2	14.6	26.4
	3/4	38.36	54.56
	1"	89.76	124.96
	1-1/4	132	167.2
	1-1/2	193.6	246.4
	2"	228.8	316.8



DF

平头粗网消声器 PBSL-R/G/NPT	规格	304	316
	M5	7.04	10.56
	1/8	5.28	8.8
	1/4	6.68	10.2
	3/8	7.92	11.44
	1/2	10.04	13.56
	3/4	23.4	26.92
	1"	36.96	40.48
	1-1/4	52.8	56.32
	1-1/2	61.6	65.12
	2"	79.2	82.72



DF

补芯	规格	价格
	1/4-01	6.60
	3/8-01/02	8.80
	1/2-02/03	11.00
	3/4-03/04	15.40
	1"-04/06	22.00



DF

平头细网消声器 PBSL-R/G/NPT	规格	304	316
	M5	7.56	11.08
	1/8	5.8	9.32
	1/4	7.56	11.08
	3/8	9.32	12.84
	1/2	11.08	14.6
	3/4	26.4	35.2
	1"	40.48	58.08
	1-1/4	59.84	77.44
	1-1/2	68.64	86.24
	2"	88	105.6



DF

管道阀 BKC-SA	规格	304	316
	4	68.8	84.8
	6	68.8	84.8
	8	68.8	84.8
	10	68.8	84.8



DF

不锈钢卡套接头

卡套直通终端 BKT-PC	规格	价格
	6-R01	5.50
	6-R02	5.50
	6-R03	7.26
	6-R04	9.68
	8-R01	5.50
	8-R02	5.50
	8-R03	7.70
	8-R04	9.90
	10-R01	7.48
	10-R02	7.92
	10-R03	7.92
	10-R04	10.12
	12-R01	9.24
	12-R02	9.24
	12-R03	9.90
	12-R04	10.56
	14-R02	12.10
	14-R03	12.54
	14-R04	13.20
	16-R02	15.18
	16-R03	15.62
	16-R04	15.84
	3-R01	7.26
	4-R01	7.26
	4-R02	7.92
	6-M10*1	6.60
	8-M10*1	7.04
	10-M10*1	7.92
	8-M14*1.5	8.80
	10-M14*1.5	9.90
DF	12-M14*1.5	11.00



卡套直角 BKT-PL	规格	价格
	6-R01	9.90
	6-R02	10.78
	6-R03	13.20
	6-R04	16.94
	8-R01	11.66
	8-R02	11.66
	8-R03	13.42
	8-R04	17.16
	10-R01	13.64
	10-R02	13.64
	10-R03	14.08
	10-R04	18.04
	12-R01	14.30
	12-R02	14.30
	12-R03	15.18
	12-R04	20.46
	14-R02	19.80
	14-R03	19.80
	14-R04	20.90
	16-R02	24.86
	16-R03	25.30
	16-R04	25.96
	3-R01	10.56
	4-R01	10.56
	4-R02	11.00
	6-M10*1	11.66
	8-M10*1	13.20
	10-M10*1	14.30
	8-M14*1.5	13.86
	10-M14*1.5	14.30
DF	12-M14*1.5	15.40



卡套直通 BKT-PU	规格	价格
	4	9.68
	6	8.58
	8	9.24
	10	10.56
	12	12.98
	14	15.84
DF	16	20.68



卡套弯通 BKT-PV	规格	价格
	4	13.20
	6	12.54
	8	14.52
	10	16.72
	12	19.80
	14	22.66
DF	16	28.60



### 不锈钢卡套接头

卡套穿板直通 BKT-PMK	规格	价格
	4	13.20
	6	13.20
	8	14.52
	10	16.72
	12	19.36
	14	28.60
	16	44.00

DF

卡套变径直通 BKT-PU	规格	价格
	6-4	10.12
	8-6	9.68
	10-6	10.56
	10-8	10.56
	12-6	13.20
	12-8	13.20
	12-10	13.64

DF

卡套三通 BKT-PE	规格	价格
	4	22.00
	6	18.70
	8	20.68
	10	23.10
	12	27.50
	14	32.56
	16	37.40

DF

卡套四通 BKT-PX	规格	价格
	4	35.20
	6	35.20
	8	37.40
	10	46.20
	12	48.40
	14	70.40
16	83.60	

DF

### 不锈钢快拧接头

快拧直通终端 BKN-PC	规格	价格
	6-R01	6.16
	6-R02	6.60
	6-R03	8.36
	6-R04	10.56
	8-R01	6.60
	8-R02	7.48
	8-R03	8.58
	8-R04	11.00
	10-R01	7.92
	10-R02	8.36
	10-R03	8.80
	10-R04	11.22
	12-R01	9.46
	12-R02	10.12
	12-R03	11.00
	12-R04	11.44
	14-R02	14.96
	14-R03	14.96
	14-R04	14.96
	16-R02	15.84
16-R03	15.84	
16-R04	15.84	
4-R01	12.10	
4-R02	12.10	

DF

快拧直通 BKN-PU	规格	价格
	6	11.00
	8	12.32
	10	14.08
	12	16.50
	14	19.80
	16	24.20
	4	17.60

DF

不锈钢快拧接头

快拧三通 BKN-PE	规格	价格
	6	21.34
	8	23.76
	10	25.30
	12	28.60
	14	44.00
	16	50.60
	DF 4	44.00

快拧穿板直通 BKN-PMK	规格	价格
	4	24.64
	6	14.30
	8	15.40
	10	18.48
	12	18.70
	14	28.60
	DF 16	39.60

快拧内螺纹直通 BKN-PCF	规格	价格
	6-R01	8.36
	6-R02	8.80
	6-R03	11.00
	6-R04	12.10
	8-R01	8.80
	8-R02	8.80
	8-R03	11.22
	8-R04	12.32
	10-R01	9.24
	10-R02	9.24
	10-R03	11.44
	10-R04	12.76
	12-R01	11.00
	12-R02	11.00
	12-R03	11.88
	DF 12-R04	13.20

内六角堵头	规格	价格
	1/8	1.58
	1/4	2.12
	3/8	4.40
	1/2	4.92
	3/4	8.44
	DF 1	17.60

BKN-PL	规格	价格
	6-R01	10.56
	6-R02	11.44
	6-R03	15.40
	6-R04	18.70
	8-R01	11.44
	8-R02	12.10
	8-R03	15.62
	8-R04	18.92
	10-R01	13.86
	10-R02	13.86
	10-R03	15.84
	10-R04	19.14
	12-R01	15.84
	12-R02	15.84
	12-R03	17.16
	12-R04	20.24
	14-R02	23.10
	14-R03	24.20
	14-R04	24.20
	16-R02	28.60
16-R03	29.70	
16-R04	30.80	
DF 4-R01	19.80	
DF 4-R02	19.80	

快拧变径直通 BKN-PG	规格	价格
	8-6	13.42
	10-6	15.84
	10-8	16.06
	12-6	17.38
	12-8	17.38
	12-10	17.38
	DF 6-4	17.60

对丝	规格	价格
	1/8	4.04
	1/4	4.92
	3/8	5.64
	1/2	7.92
	3/4	11.62
	DF 1	16.90

铁接头

铁宝塔 PC	型号	单价
	8-01	0.84
	8-02	0.84
	8-03	1.28
	8-04	1.50
	10-01	0.94
	10-02	0.94
	10-03	1.28
	10-04	1.50
	10-06	3.30
	12-02	1.44
	12-03	1.54
	12-04	1.66
	12-06	3.30
	13-04	1.98
	14-03	1.88
	14-04	1.98
	14-06	3.74
	16-03	1.88
	16-04	1.88
	16-06	3.96
	16-G1	4.40
	19-04	2.20
	19-06	3.30
	19-G1	5.50
	25-G1	5.50
	25-06	5.06
	32-G1	9.90
DC	32-1-1/42	14.30



铁堵头	型号	单价
	1/8	0.20
	1/4	0.24
	3/8	0.56
	1/2	1.00
	3/4	2.64
	G1	5.50
DC		



消声器

宝塔消声器 (铜芯铁座)	型号	单价
	1/8	0.66
	1/4	1.38
	3/8	2.54
	1/2	3.52
	3/4	2.64
	G1	15.40
DC		



铁平头消声器	型号	单价
	1/8	0.56
	1/4	1.06
	3/8	1.76
DC	1/2	2.42



铁对丝	型号	单价
	1/4	0.78
	3/8	1.06
	1/2	0.84
	3/4	1.54
	1/4-3/8	1.06
	1/4-1/2	0.78
	3/8-1/2	0.99
DC	1/2-3/4	1.54



节流消声器	型号	单价
	1/8	2.68
	1/4	2.92
	3/8	6.28
	1/2	9.90
	3/4	20.24
DC	G1	44.00





消声器

节流（内罩）消声器	型号	单价
	1/8	4.74
	1/4	5.94
	3/8	10.34
	1/2	14.30

DC

弹簧消声器	型号	单价
	1/8	3.52
	1/4	3.96
	3/8	10.56
	1/2	13.20

DC

铜平头消声器	型号	单价
	M5	1.00
	1/8	0.80
	1/4	1.32
	3/8	1.88
	1/2	2.54
	3/4	6.60
	G1	11.88
	1-1/4	44.00
	1-1/2	55.00
	G2	77.00

DC

全铜消声器	型号	单价
	M5	1.10
	1/8	1.04
	1/4	1.72
	3/8	3.04
	1/2	4.08
	3/4	11.00
	G1	19.80
	G1-1/4	55.00
	G1-1/2	77.00
	G2	99.00

DC

塑料消声器	型号	单价
	1/8 (黑)	0.66
	1/4 (黑)	0.66
	3/8 (黑)	2.42
	1/2 (黑)	3.42
	3/4 (黑)	11.00
	G1 (黑)	11.00
	1/4 (白)	0.66
	1/8 (白)	0.66
	1/8 (蓝)	0.66
	1/4 (蓝)	0.66
	3/8 (蓝)	2.42
	1/2 (蓝)	3.42
	3/4 (蓝)	11.00
	G1 (蓝)	11.00
	1/8 (橘红)	0.88
	1/4 (橘红)	1.10
	3/8 (橘红)	1.66
1/2 (橘红)	2.10	

DC

球阀

球阀双内	型号	单价
	1/4	3.20
	3/8	4.30
	1/2	5.90

DC

球阀

球阀双外	型号	单价
	1/4	3.20
	3/8	4.30
	1/2	5.90
DC		

球阀内外	型号	单价
	1/4	3.20
	3/8	4.30
	1/2	5.90
DC		

球阀外丝	型号	单价
	1/4-8	3.20
	1/4-10	3.20
	3/8-8	3.74
	3/8-10	3.74
	1/2-8	4.30
	1/2-10	4.30
	1/2-12	4.62
DC		

球阀内丝	型号	单价
	1/4-8	3.20
	1/4-10	3.20
	3/8-8	4.08
	3/8-10	4.08
	1/2-8	4.62
	1/2-10	4.62
	DC	

球阀宝塔双头	型号	单价
	φ6	3.74
	φ8	3.20
	φ10	3.20
DC		

球阀

加厚球阀双内	型号	单价
	1/4	8.14
	3/8	10.56
	1/2	10.56
	3/4	16.06
	G1	26.40
	G1-1/4	44.00
	G1-1/2	66.00
	G2	103.40
DC		

加厚球阀内外	型号	单价
	1/4	8.36
	3/8	10.56
	1/2	10.56
	3/4	19.80
	G1	28.60
	DC	

加厚球阀外丝	型号	单价
	1/4-8	8.36
	1/4-10	8.36
	3/8-8	8.36
	3/8-10	8.36
	1/2-8	8.36
	1/2-10	8.36
	1/2-12	9.90
DC		

迷你球阀内外	型号	单价
	1/8	11.00
	1/4	10.56
	3/8	11.66
	1/2	13.86
DC		

迷你球阀内丝	型号	单价
	1/8	11.00
	1/4	10.56
	3/8	12.10
	1/2	14.30
DC		

球阀

快拧球阀	型号	单价
	6-02	6.16
	8-02	6.16
	10-02	7.04
	6-04	8.14
	8-04	8.36
	10-04	8.36

DC

永德信球阀双内	型号	单价
	1/4	15.84
	3/8	33.00
	1/2	33.00

DC

永德信球阀内外	型号	单价
	1/4	17.16
	3/8	33.00
	1/2	33.00

DC

蝶柄球阀双内	型号	单价
	1/4	10.56
	3/8	14.30
	1/2	14.30

DC

安全阀

红帽安全阀	型号	单价
	1/8	4.18
	1/4	4.18

DC

针型阀

针型阀	型号	单价
	φ6	7.26
	φ8	7.70
	φ10	10.34
	φ12	12.76
	1/8	7.26
	1/4	9.68

DC

直角针型阀	型号	单价
	1/8	7.70
	1/4	10.34

DC

全铜针型阀内丝 / 直角	型号	单价
	1/4	14.30

DC

蝶柄球阀内外	型号	单价
	1/4	10.56
	3/8	14.30
	1/2	14.96

DC

安全阀

大丰安全阀	型号	单价
	1/4	9.46
	3/8	9.24
	1/2	9.24

DC

快拧直通迷你型	型号	单价
	4-M3	1.38
	4-M4	2.09
	4-M5	1.22
	4-M6	1.44
	6-M5	1.54
	6-M6	1.98

DC

快拧弯头迷你型	型号	单价
	4-M3	2.42
	4-M4	3.63
	4-M5	2.20
	4-M6	2.54
	6-M5	2.54
	6-M6	2.64

DC

十字四通接头	规格	单价
	KQ2TW04-00	5.48
	KQ2TW06-00	6.00
	KQ2TW08-00	6.84
	KQ2TW10-00	9.40
	KQ2TW12-00	10.28

DD

五通接头	规格	单价
	KQ2UD04-06	6.84
	KQ2UD06-08	8.56

DD

SMC 型接头

等径弯接头	规格	单价
	KQ2L04-00	2.56
	KQ2L06-00	2.92
	KQ2L08-00	3.42
	KQ2L10-00	4.96
	KQ2L12-00	6.00

DD

变径弯接头	规格	单价
	KQ2L04-06	2.74
	KQ2L06-08	3.08
	KQ2L08-10	3.76
	KQ2L10-12	6.50

DD

直接堵接头	规格	单价
	KQ2P-04	0.86
	KQ2P-06	0.86
	KQ2P-08	0.86
	KQ2P-10	1.02
	KQ2P-12	1.02

DD

管道型调节	规格	单价
	AS1001F-04	8.74
	AS2001F-04	10.28
	AS1001F-06	8.74
	AS2001F-06	10.28
	AS2051F-06	13.70
	AS3001F-06	19.18
	AS2051F-08	13.70
	AS3001F-08	19.18
	AS3001F-10	19.18
	AS4001F-10	27.56
	AS3001F-12	19.18
	AS4001F-12	27.56

DD

SMC 型旋转接头

两侧快换接头	规格	单价
	AKH04-00	12.24
	AKH06-00	12.24
	AKH08-00	14.30
	AKH10-00	20.54
	AKH12-00	29.10

DD

VHK 手动阀	规格	单价
	VHK2-04F-04F	11.98
	VHK2-06F-06F	11.98
	VHK2-08F-08F	11.98
	VHK2-10F-10F	15.40
	VHK2-12F-12F	17.12
	VHK3-04F-04F	11.98
	VHK3-06F-06F	11.98
	VHK3-08F-08F	11.98
	VHK3-10F-10F	15.40
	VHK3-12F-12F	17.12

DD

直通旋转接头	规格	单价
	KSH04-M5	32.10
	KSH04-M6	32.10
	KSH04-01S	33.38
	KSH06-M5	32.10
	KSH06-M6	32.10
	KSH06-01S	33.38
	KSH06-02S	33.64
	KSH08-01S	39.68
	KSH08-02S	40.32
	KSH08-03S	40.96
	KSH10-02S	51.36
	KSH10-03S	52.64
	KSH10-04S	53.92
	KSH12-03S	64.20
KSH12-04S	64.20	

DD

内螺直接头	规格	单价
	KQ2F04-01	3.94
	KQ2F04-02	5.48
	KQ2F06-01	4.62
	KQ2F06-02	5.64
	KQ2F06-03	8.56
	KQ2F08-01	4.80
	KQ2F08-02	6.34
	KQ2F08-03	7.20
	KQ2F10-01	6.94
	KQ2F10-02	7.20
	KQ2F10-03	8.38
	KQ2F10-04	12.50
	KQ2F12-02	10.28
	KQ2F12-03	10.28
KQ2F12-04	13.36	

DD

弯通旋转接头	规格	单价
	KSL04-M5	32.10
	KSL04-M6	32.10
	KSL04-01S	33.38
	KSL06-M5	32.10
	KSL06-M6	32.10
	KSL06-01S	33.38
	KSL06-02S	33.38
	KSL08-01S	39.80
	KSL08-02S	40.44
	KSL08-03S	41.08
	KSL10-02S	52.00
	KSL10-03S	53.28
	KSL10-04S	54.58
	KSL12-03S	64.20
KSL12-04S	64.20	

DD

T 型三通接头	规格	单价
	KQ2T04-00	3.60
	KQ2T06-00	3.94
	KQ2T08-00	4.46
	KQ2T10-00	6.34
	KQ2T12-00	7.36
	KQ2T16-00	20.54

DD

T 型变 1 三通	规格	单价
	KQ2T06-04	4.46
	KQ2T08-06	4.96
	KQ2T10-08	6.16
	KQ2T12-10	7.88

DD

SMC 型接头

T型变2三通	规格	单价
	KQ2T04-06	3.94
	KQ2T06-08	4.28
	KQ2T08-10	5.30
	KQ2T10-12	6.84

变径直接头	规格	单价
	KJH03-04	3.08
	KJH04-06	3.08

等径Y型接头	规格	单价
	KQ2U04-00	3.76
	KQ2U06-00	4.10
	KQ2U08-00	4.62
	KQ2U10-00	6.50
	KQ2U12-00	7.36

变径Y型接头	规格	单价
	KQ2U04-06-04	4.28
	KQ2U06-08-06	4.62
	KQ2U08-10-08	5.64
	KQ2U10-12-10	7.70

等径直接头	规格	单价
	KQ2H04-00	2.40
	KQ2H06-00	2.74
	KQ2H08-00	3.26
	KQ2H10-00	4.46
	KQ2H12-00	5.48
	KQ2H16-00	12.84

变径直接头	规格	单价
	KQ2H04-06	2.56
	KQ2H04-08	5.64
	KQ2H06-08	3.08
	KQ2H06-10	6.16
	KQ2H08-10	4.46
	KQ2H08-12	8.90
	KQ2H10-12	5.48

变径端插接头	规格	单价
	KQ2R04-06	2.66
	KQ2R04-08	2.74
	KQ2R04-10	2.92
	KQ2R06-04	3.08
	KQ2R06-08	3.08
	KQ2R06-10	3.08
	KQ2R06-12	3.60
	KQ2R08-10	3.60
	KQ2R08-12	3.76
	KQ2R10-12	3.94

内六角接头	规格	单价
	KQ2S04-01S	2.32
	KQ2S04-02S	2.52
	KQ2S06-01S	2.32
	KQ2S06-02S	2.52
	KQ2S08-01S	2.72
	KQ2S08-02S	2.72
	KQ2S08-03S	4.46
	KQ2S08-04S	8.14
	KQ2S10-01S	4.24
	KQ2S10-02S	5.04
	KQ2S10-03S	5.14
	KQ2S10-04S	8.56
	KQ2S12-02S	6.84
	KQ2S12-03S	6.84
	KQ2S12-04S	8.56

SMC 型接头

外螺直接头	规格	单价
	KQ2H04-01S	2.32
	KQ2H04-02S	2.52
	KQ2H06-01S	2.32
	KQ2H06-02S	2.52
	KQ2H06-03S	4.62
	KQ2H06-04S	9.84
	KQ2H08-01S	2.72
	KQ2H08-02S	2.72
	KQ2H08-03S	4.46
	KQ2H08-04S	9.84
	KQ2H10-01S	4.24
	KQ2H10-02S	5.04
	KQ2H10-03S	5.14
	KQ2H10-04S	8.56
	KQ2H12-02S	6.84
	KQ2H12-03S	6.84
	KQ2H12-04S	8.56
	KQ2H16-03S	13.70
	KQ2H16-04S	13.86



DD

内螺直接头	规格	单价
	KJF04-M5	2.22
	KJF06-M5	2.22



DD

外螺弯接头	规格	单价
	KJL03-M3	2.74
	KJL04-M3	2.48
	KJL04-M5	2.40
	KJL04-M6	2.56
	KJL04-01S	2.62
	KJL06-M5	2.74
	KJL06-M6	2.74
	KJL06-01S	2.82



DD

外螺直接头	规格	单价
	KJH03-M3	2.22
	KJH03-M5	2.14
	KJH04-M3	2.06
	KJH04-M5	2.06
	KJH04-M6	2.06
	KJH04-01S	2.32
	KJH06-M5	2.22
	KJH06-M6	2.22
	KJH06-01S	2.32



DD

内六角直接头	规格	单价
	KJS04-M3	2.06
	KJS04-M5	2.06
	KJS04-M6	2.06
	KJS04-01S	2.32
	KJS06-M5	2.22
	KJS06-M6	2.22
	KJS06-01S	2.32



DD

隔板接头	规格	单价
	KQ2E04-00	5.64
	KQ2E06-00	6.84
	KQ2E08-00	8.22
	KQ2E10-00	13.36
	KQ2E12-00	17.98
	KQ2E16-00	29.10



DD

内螺隔板接头	规格	单价
	KQ2E04-01	6.16
	KQ2E06-01	6.84
	KQ2E06-02	7.20
	KQ2E06-03	8.74
	KQ2E08-01	7.70
	KQ2E08-02	8.22
	KQ2E08-03	9.42
	KQ2E10-02	13.52
	KQ2E10-03	13.52
	KQ2E12-03	16.26



DD

### SMC 型接头

限出型调节	规格	单价
	AS1201F-M3-04	9.24
	AS1201F-M5-04	9.24
	AS2201F-01-04	10.28
	AS2201F-02-04	13.52
	AS1201F-M5-06	9.24
	AS2201F-01-06	10.28
	AS2201F-02-06	13.52
	AS3201F-03-06	20.38
	AS2201F-01-08	10.28
	AS2201F-02-08	13.52
	AS3201F-03-08	20.38
	AS2201F-01-10	10.62
	AS2201F-02-10	13.52
	AS3201F-03-10	20.38
	AS4201F-04-10	27.74
	AS3201F-03-12	20.88

DD

外螺弯接头	规格	单价
	KQ2L04-01S	2.62
	KQ2L04-02S	3.16
	KQ2L06-01S	2.82
	KQ2L06-02S	3.16
	KQ2L06-03S	5.64
	KQ2L08-01S	2.92
	KQ2L08-02S	3.22
	KQ2L08-03S	6.00
	KQ2L10-01S	4.44
	KQ2L10-02S	5.24
	KQ2L10-03S	6.50
	KQ2L10-04S	10.96
	KQ2L12-02S	6.34
	KQ2L12-03S	8.04
	KQ2L12-04S	11.30
	KQ2L16-03S	15.76
KQ2L16-04S	16.94	

DD

等径直接头	规格	单价
	KJH03-00	3.08
	KJH04-00	3.08
	KJH06-00	3.08

DD

隔板弯接头	规格	单价
	KQ2LE04-00	6.68
	KQ2LE06-00	7.70
	KQ2LE08-00	8.74
	KQ2LE10-00	14.56
	KQ2LE12-00	19.68

DD

SC 支架	型号	单价
	ZJ32-50	2.00
	ZJ63	2.00
	ZJ80-100	2.00
	ZJ32-100	3.00
	ZJ32-125	3.40

DD

### 磁性开关

亚德客型磁性开关	型号	单价
	CS1-F	8.00
	CS1-U	8.00
	CS1-J	8.00
	CS1-S	8.00
	CS1-G	8.00
	CS1-F-020	14.00
	CS1-U-020	14.00
	CS1-M-020	18 (扎带 +4.4)
	CS1-A-020	22

FA



磁性开关

电子式无触点

亚德客型磁性开关	型号	单价
	DMSE-2W	20.00
	DMSH-2W	20.00
	DMSJ-2W	20.00
	DMSG-2W	20.00
	DMSG-2W	27.00
	DMSHS-2W	27.00
	CMSH-020	18.00
	CMSG-020	18.00
	CMSE-020	18.00
	CMSJ-020	18.00

FA

SMC 型磁性开关	型号	单价
	D-M9B	21.00
	D-M9N	21.00
	D-M9P	21.00
	D-M9BV	21.00
	D-M9NV	21.00
	D-M9PV	21.00
	D-F8B	21.00
	D-F8N	21.00
	D-F8P	21.00
	D-R731	33.00
	D-R732	33.00
	D-A73	10.00
	D-C73	10.00
	D-Z73	10.00
	D-A93	10.00
	D-A54	18.00
D-B54	22.00	

FA

MA 扎带架	型号	单价
	F-MQS8	6
	F-MQS10	6
	F-MQS12	6
	F-MQS16	6
	F-MQS20	6
	F-MQS25	6
	F-MQS32	6
	F-MQS40	6

FA

SC 支架	型号	缸径	单价
	F-SC32-50SH	32~50	6.00
	F-SC63SH	63	6.00
	F-SC80-100SH	80~100	6.00
	F-SC125SH	125	6.00
	F-SC160-200SH	160~200	7.00
	F-SC250SH	250	8.00

FA

费斯托型磁性开关	型号	单价
	SME-8-ZS-KL-LED	22.00
	SME-8K-LED	26.00
	SME-8M-ZS-24V-K	32.00
	SME-8M-DS-24V-K	43.00
	SME-8M-DS-24V-K-0.3-M8E	64.00

FA

Z73 支架 / A73 支架 / SS 扎带	型号	单价
	BQ-2BQ2-013 (锌支架)	4.00
	F 万能扎带 (方形孔)	3.00
	S 万能扎带 (方形孔)	3.00
	F 万能扎带 (圆形孔)	2.80

FA

数显压力开关	型号	单价
	DPSN1-01-020	130.00
	DPSN1-10-020	130.00
	DPSP1-01-020	130.00
	DPSP1-10-020	130.00
	附件 F-DPSEB	6.00
	附件 F-DPSLB	6.00
	松下款 DP-100	260.00

FA

注：正压、负压、混合压同价。

SC 支架 (精品)	型号	单价
	SM-6	6.00
	SM-8	6.00
	SM-10	6.00
	SM-12	7.00
	SM-14	7.00
	SM-16	8.00

FA

C73 扎带	型号	单价
	BM-10	3.40
	BM-16	3.40
	BM-20	3.40
	BM-25	3.40
	BM-32	3.40
	BM-40	3.40

FA

SU 支架	型号	单价
	SUφ32-40	7.00
	SUφ50-63	7.00
	SUφ80	8.00
	SUφ100	8.00
	SUφ125	9.00

FA

SC 支架 (MDBB 支架)	型号	单价
	BMB5-032	5.00
	BA7-063	5.00
	BA7-080	5.00
	BS5-125	6.00
	BS5-140	6.00
	BS5-160	6.00

FA

### 气动震动器

GT 系列 齿轮型气动震动器	型号	单价
	GT4	128.60
	GT6	128.60
	GT8	101.00
	GT10	101.00
	GT13	148.80
	GT16	148.80
	GT20	220.40
	GT25	220.40
	GT30	345.20
	GT32	345.20
	GT36	345.20
	GT40	550.80
	GT48	550.80

FK

K 系列 滚珠型气动震动器	型号	单价
	K8	45.00
	K10	45.00
	K13	74.40
	K16	74.40
	K20	137.80
	K25	137.80
	K30	220.40
	K32	220.40
	K36	220.40

FK

缓冲器

AD 系列液压缓冲器	型号	单价
	AD1410	45.36
	AD1412	45.36
	AD1416	45.36
	AD1420	47.52
	AD1425	51.84
	AD2016	71.28
	AD2020	71.28
	AD2025	71.28
	AD2030	71.28
	AD2050	86.40
	AD2525	90.72
	AD2530	90.72
	AD2540	97.20
	AD2550	108.00
	AD2580	140.40
	AD3625	151.20
	AD3650	162.00
	AD4225	172.80
	AD4250	183.60
	AD4275	216.00



FG

缓冲器

AC 系列液压缓冲器	型号	单价
	AC0806	19.44
	AC1005	20.52
	AC1008	20.52
	AC1210	22.68
	AC1410	38.88
	AC1412	38.88
	AC1416	43.20
	AC1420	45.36
	AC1425	49.68
	AC2015	62.64
	AC2020	62.64
	AC2025	62.64
	AC2030	62.64
	AC2050	78.84
	AC2525	82.08
	AC2530	82.08
	AC2540	84.24
	AC2550	97.20
	AC2580	108.00
	AC3660	162.00



FG

HR 系列液压缓冲器	型号	单价
	HR15/SR2415	118.80
	HR30/SR2430	129.60
	HR60/SR2460	129.60
	HR80/SR2480	172.80
	HR100/SR24100	205.20
	HR15/SR2415	118.80
	HR30/SR2430	129.60
	HR60/SR2460	129.60
	HR80/SR2480	172.80
	HR100/SR24100	205.20
	HR15/SR2415	118.80
	HR30/SR2430	129.60
	HR60/SR2460	129.60
	HR80/SR2480	172.80
	HR100/SR24100	205.20



FG

RB 系列液压缓冲器	型号	单价
	RB0806	33.48
	RBC0806	33.48
	RB1007	34.56
	RBC1007	34.56
	RB1412	54.00
	RBC1412	54.00
	RB2015	64.80
	RBC2015	64.80
	RB2725	118.80
	RBC2725	140.40



FG

### 真空发生器

盒型真空发生器	规格	单价
	ZH05BS-06-06	27.82
	ZH07BS-06-06	27.82
	ZH10BS-06-06	27.82
	ZH13BS-08-10	34.24
	ZH05BS-01-01	32.10
	ZH07BS-01-01	32.10
	ZH10BS-01-01	32.10
	ZH13BS-01-02	34.24

DD

直接接管型真空发生器	规格	单价
	ZH05DS-06-06	20.34
	ZH07DS-06-06	20.34
	ZH10DS-06-06	20.34
	ZH13DS-08-10	27.82
	ZH05DS-01-01	29.96
	ZH07DS-01-01	29.96
	ZH10DS-01-01	29.96
	ZH13DS-01-02	34.24

DD

### 真空发生器

CV 系列真空发生器	型号	单价
	CV-10HS-AL	12.00
	CV-15HS-AL	22.00
	CV-20HS-AL	36.00
	CV-25HS-AL	56.00

FB

直管型真空发生器	规格	单价
	ZU05S	12.84
	ZU07S	12.84
	ZU05L	12.84
	ZU07L	12.84

DD

EV 系列真空发生器	型号	单价
	EV-10	14.00
	EV-15	28.00
	EV-20	40.00
	EV-25	62.00

FB

真空过滤器	规格	单价
	ZFC100-04B	10.70
	ZFC100-06B	10.70
	ZFC200-06B	11.78
	ZFC200-08B	11.78

DD

真空输送机	型号	单价
	ZH10-X185	115.00
	ZH10-B-X185	121.90
	ZH20-X185	195.50
	ZH20-B-X185	211.60
	ZH30-X185	368.00
	ZH30-B-X185-B	391.00
	ZH40-X185	644.00
	ZH40-B-X185	678.50
	ZH19-X187	103.50
	ZH25-X187	115.00
	ZH32-X187	138.00

AA

### 撞击锤

SK 系列 气动缓冲敲击锤	型号	单价
	SK30	229.60
	SK40	284.60
	SK60	477.40
	SK80	918.00
	SK100	1744.20

FK

### 冷风枪

TC 冷风枪	型号	单价
	TC010	1544.40
	TC010(带强磁)	1652.40

FK

吹尘枪

高性价比

A1 款 塑料吹尘枪	型号	单价
	A001(短嘴、铜螺纹)	7.60
	A001(长嘴、铜螺纹)	10.80
	A001(短嘴)	7.00
	A001(长嘴)	10.40
FH		

A7 款 塑料吹尘枪	型号	单价
	A007(标准嘴)	56.00
	A007(长嘴)	66.00
	A007(特长嘴)	76.00
	A010(标准嘴)	13.00
	A015(短嘴)	10.00
	A015(长嘴)	13.00
FH		

AR 款塑料吹尘枪	型号	单价
	ARTS(长嘴)	5.80
	AR(短嘴)	3.40
FH		

A18 金属吹尘枪	型号	单价
	A018(标准嘴)	22.00
	A018(长嘴)	28.00
FH		

A98 金属吹尘枪	型号	单价
	A098(调速枪嘴)	19.80
FH		

膜片式压力开关	型号	单价
	QPM11-NO	36.00
	QPM11-NC	36.00
FF		

冷却管磁座	型号	单价
	磁座 2分一进一出	13.2
	磁座 3分一进一出	13.2
	磁座 4分一进一出	13.2
FF		

喷雾器	型号	单价
	灰色球阀喷雾器	38.00
	蓝色球阀品武器	44.00
	二代喷雾器	130.00
FF		

冷却管	型号	单价	带开关	备注
	(1/4) 2*300L	3.30	+2.2	+100L=1.1
	(3/8) 3/400L	6.60	+3.3	+100L=1.76
	(1/2) 4*400L	8.80	+3.3	+100L=2.2
	(3/4) 6*500L	17.60		+100L=3.3
FF				

### 空气消耗量计算方法

$$QA=(A1+A2) \times L \times \frac{P+1.033}{1.033} \times 10^{-3} \quad QB=2 \times A3L \times LH \times \frac{P}{1.033} \times 10^{-3} \quad Qn=(QA+QB) \times n$$

- |                                  |                                 |
|----------------------------------|---------------------------------|
| QN : 气缸作动之空气消耗量 (■ /min)         | A3 : 配管之管内径 (cm <sup>2</sup> )  |
| QA : 气缸往复作动之空气量 / 次 (■ /min)     | L : 气缸之行程 (cm)                  |
| QB : 配管之空气消耗量 (电磁阀至气缸间) (■ /min) | LH : 配管长度 (cm)                  |
| A1 : 推出之受压面积 (cm <sup>2</sup> )  | P : 操作压力 (kgf/cm <sup>2</sup> ) |
| A2 : 拉入之受压面积 (cm <sup>2</sup> )  | n : 操作频率                        |

### 气缸出力计算式

$$F=P \times A - f$$

F : 气缸出力 (kgf)      A : 截面积 (cm<sup>2</sup>)  
 P : 使用压力 (kgf/cm<sup>2</sup>)      f : 摩擦阻力 (kgf)  
 A :  $\pi \times \text{缸径}^2 / 40$  (cm<sup>2</sup>)

### 气缸出力表

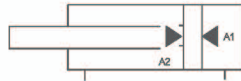

缸径 (mm)		10	12	16	20	25	32	40	50	63	80	100	125	
轴径 (mm)		4	6	6	8	10	12	16	20	20	25	25	36	
受压面积 (cm <sup>2</sup> )	A1	0.8	1.1	2.0	3.1	4.9	8.0	12.5	19.6	31.2	50.2	78.5	122.7	
	A2	0.6	0.9	1.7	2.6	4.1	6.9	10.6	16.5	28.0	45.3	73.6	112.5	
操作压力 (kgf/cm <sup>2</sup> )	1	A1	0.8	1.1	2.0	3.1	4.9	8.0	12.6	19.6	31.2	50.2	78.5	122.7
		A2	0.6	0.9	1.7	2.6	4.1	6.9	10.6	16.5	28.0	45.3	73.6	112.5
	2	A1	1.6	2.3	4.0	6.3	9.8	16.1	25.1	39.3	62.3	100.5	157.0	245.4
		A2	1.2	1.7	3.5	5.3	8.2	13.8	21.1	33.0	56.0	90.7	147.2	225
	3	A1	2.4	3.4	6.0	9.4	14.7	24.1	37.7	58.9	93.5	150.7	235.5	368.1
		A2	1.8	2.5	5.2	7.9	12.4	20.7	31.7	49.5	84.0	136.0	220.8	337.5
	4	A1	3.2	4.5	8.0	12.6	19.6	32.2	50.2	78.5	124.6	201.0	314.0	490.8
		A2	2.4	3.4	6.9	10.6	16.5	27.6	42.2	65.9	112.1	181.3	294.4	450
	5	A1	4.0	5.7	10.1	15.7	24.5	40.2	62.8	98.1	155.8	251.2	392.5	613.5
		A2	3	4.2	8.7	13.2	20.6	34.5	52.8	82.4	140.1	226.7	368.0	562.5
	6	A1	4.7	6.8	12.1	18.9	29.4	48.2	75.4	117.8	186.9	301.4	471.0	736.2
		A2	3.6	5.1	10.4	15.8	24.7	41.5	63.3	98.9	168.1	272.0	441.6	675
	7	A1	5.5	7.9	14.1	22.0	34.3	56.3	87.9	137.4	218.1	351.7	549.5	858.9
		A2	4.2	5.9	12.1	18.5	28.9	48.4	73.9	115.4	196.1	317.3	515.2	787.5
	8	A1	6.3	9.0	16.1	25.1	39.3	64.3	100.5	157.0	249.3	401.9	628.0	981.6
		A2	4.8	6.8	13.8	21.1	33.0	55.3	84.4	131.9	224.1	362.7	588.8	900
	9	A1	7.1	10.2	18.1	28.3	44.2	72.3	113.0	176.6	280.4	452.2	706.5	1104.3
		A2	5.4	7.6	15.5	23.8	37.1	62.2	95.0	148.4	252.1	408.0	622.4	1012.5



国家气动产品质量监督检验中心  
National Quality Supervision and Inspection  
Center of Pneumatic Products (NCPP)

# 东莞天米智能装备科技有限公司

 4008-270-668

手机1: 134-1222-6797

手机2: 186-8005-2736

网址: [www.goldenhorn.cn](http://www.goldenhorn.cn)

地址: 广东省东莞市莞城区八达电子城 1 号

“金角兽”机械自动化设备控制系统产品提供商, 更多产品详情介绍登入网站

网址: [www.goldenhorn.cn](http://www.goldenhorn.cn)



扫码进入商城



咨询客服1



咨询客服2